

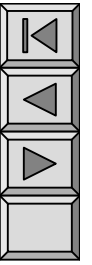

KCL KVL VCR

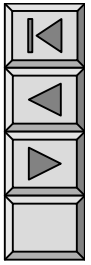

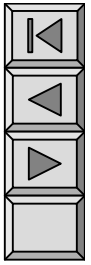



7

11

§ 14 1

1.



$f(t)$

$F(s)$

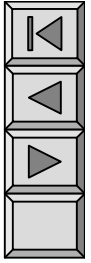

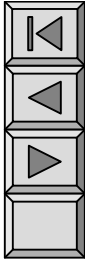

1.

$$F(s) = \int_{0^-}^{+\infty} f(t) e^{-st} dt$$

$$F(s) = \int_{0^-}^{+\infty} f(t) e^{-st} dt$$

$$s = \sigma + j\omega$$

$$F(s) \quad f(t) \quad f(t) \quad F(s)$$

$$F(s) \quad f(t)$$

$$f(t) = \int_C^{-1} [F(s)] = \frac{1}{2\pi j} \int_{c-j}^{c+j} F(s) e^{st} dt$$

C



$$(1) \quad F(s) = \int_{t=0_-}^{\infty} f(t) e^{-st} dt = \int_{0_-}^{0_+} f(t) e^{-st} dt + \int_{0_+}^{\infty} f(t) e^{-st} dt$$

$$(2) \quad \begin{matrix} F(s) & & I(s) & U(s) \\ f(t) & & i(t) & u(t) \\ F(s) & & \text{Re}[s]=s > c & \\ & & & (\\ & & & f(t) \\ & & & F(s) \end{matrix}$$



2.

P345 14-1

$$(1) \quad f(t) = \varepsilon(t)$$

$$F(s) = \int_{0_-}^{\infty} \varepsilon(t) e^{-st} dt = \int_{0_-}^{\infty} e^{-st} dt = -\frac{1}{s} e^{-st} \Big|_{0_-}^{\infty} \quad [\varepsilon(t)] = \frac{1}{s}$$

$$(2) \quad \delta(t)$$

$$F(s) = \int_{0_-}^{\infty} \delta(t) e^{-st} dt = \int_{0_-}^{0_+} \delta(t) e^{-st} dt = e^{-s(0)} \quad [\delta(t)] = 1$$

$$(3) \quad f(t) = e^{\alpha t} \quad (\alpha \quad)$$

$$F(s) = \int_{0_-}^{\infty} e^{\alpha t} e^{-st} dt = \int_{0_-}^{\infty} e^{-(s-\alpha)t} dt = \frac{1}{-(s-\alpha)} e^{-(s-\alpha)t} \Big|_{0_-}^{\infty}$$

$$[e^{\alpha t}] = \frac{1}{s-\alpha}$$





P346 14 2 $f_1(t)=\sin(\omega t)$, $f_2(t)=K(1-e^{-\alpha t})$
[0,],

$$\begin{aligned} [f_1(t)] &= [\sin(\omega t)] = \left[\frac{1}{2j} (e^{j\omega t} - e^{-j\omega t}) \right] \\ &= \frac{1}{2j} [e^{j\omega t}] - [e^{-j\omega t}] \quad [e^{\alpha t}] = \frac{1}{s-\alpha} \\ &= \frac{1}{2j} \left[\frac{1}{s-j\omega} - \frac{1}{s+j\omega} \right] = \frac{\omega}{s^2+\omega^2} \quad [\sin(\omega t)] = \frac{\omega}{s^2+\omega^2} \end{aligned}$$

$$\begin{aligned} [f_2(t)] &= [K(1-e^{-\alpha t})] = [K] - [Ke^{-\alpha t}] \\ &= \frac{K}{s} - \frac{K}{s+\alpha} = \frac{K\alpha}{s(s+\alpha)} \quad [K(1-e^{-\alpha t})] = \frac{K\alpha}{s(s+\alpha)} \end{aligned}$$

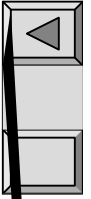

P347 14 3

$\cos(\omega t)$ $\delta(t)$

$$\frac{d\sin(\omega t)}{dt} = \omega \cos(\omega t)$$

$$\frac{d\varepsilon(t)}{dt} = \delta(t)$$

$$[\sin(\omega t)] = \frac{\omega}{s^2 + \omega^2} \quad [\varepsilon(t)] = 1/s$$

$$[\cos(\omega t)] = \left[\frac{1}{\omega} \frac{d\sin(\omega t)}{dt} \right] = \frac{1}{\omega} \left[s \frac{\omega}{s^2 + \omega^2} - \sin(0_-) \right]$$

$$[\cos(\omega t)] = \frac{s}{s^2 + \omega^2}$$

$$[\delta(t)] = \left[\frac{d\varepsilon(t)}{dt} \right] = s \left(\frac{1}{s} - 0 \right) = 1$$

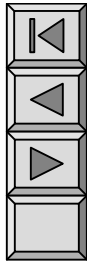

3.

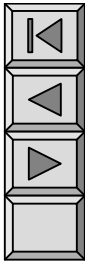

P349 14 5

$$f(t) = A [\varepsilon(t) - \varepsilon(t - \tau)]$$

$$[\varepsilon(t)] = \frac{1}{s}$$

$$[\varepsilon(t - \tau)] = \frac{1}{s} e^{-s\tau}$$

$$[f(t)] = \frac{A}{s} - \frac{A}{s} e^{-s\tau} = \frac{A}{s} (1 - e^{-s\tau})$$

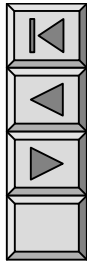
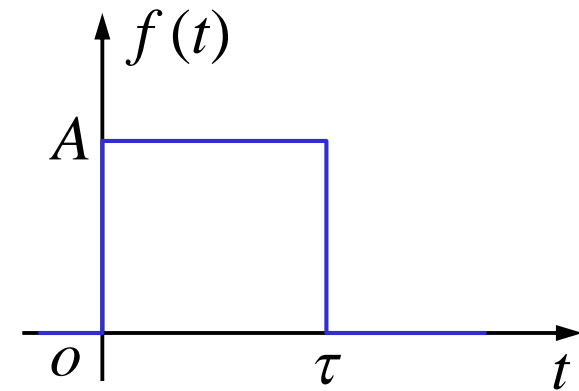

*5. $[e^{at} f(t)] = F(s - a)$

*6. $f(0) = [s F(s)]_{s \rightarrow \infty}$

*7. $f(\infty) = [s F(s)]_{s \rightarrow 0}$

P350 14-1

§ 14 3

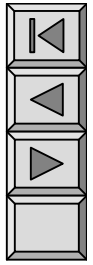

$$f(t) = \frac{1}{2\pi j} \int_{c-j}^{c+j} F(s) e^{st} ds$$

14-1

$F(s)$

$$F(s) = F_1(s) + F_2(s) + \dots$$

$$f(t) = f_1(t) + f_2(t) + \dots$$



$$F(s) = \frac{1}{s^2 + 3}$$

$$F(s) = \frac{1}{\sqrt{3}} \frac{\sqrt{3}}{s^2 + (\sqrt{3})^2}$$

$$[\sin(\omega t)] = \frac{\omega}{s^2 + \omega^2}$$

$$f(t) = \frac{1}{\sqrt{3}} \sin \sqrt{3} t$$



1.

$$F(s) = \frac{N(s)}{D(s)} = \frac{a_0 s^m + a_1 s^{m-1} + \dots + b_m}{b_0 s^n + b_1 s^{n-1} + \dots + b_n}$$

$m \quad n \qquad \qquad \qquad n \quad m$

14 1

$n > m \quad F(s)$

$n = m$

$$F(s) = A + \frac{N_0(s)}{D(s)}$$

$$D(s)=0$$

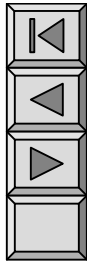

1 $D(s)=0$

$$F(s) = \frac{K_1}{s-p_1} + \frac{K_2}{s-p_2} + \dots + \frac{K_n}{s-p_n}$$

$$p_1 \quad p_2 \quad \dots \quad p_n \quad D(s)=0 \quad n$$

()

$$K_1 \quad K_2 \quad \dots \quad K_n$$

1 $K_i = \lim_{s \rightarrow p_i} (s-p_i)F(s) \quad i=1,2,3, \dots, n$

2 $K_i = \lim_{s \rightarrow p_i} \frac{(s-p_i)N(s)}{D(s)} = \lim_{s \rightarrow p_i} \frac{(s-p_i)N'(s)+N(s)}{D'(s)} = \frac{N(p_i)}{D'(p_i)}$

$$i=1,2,3, \dots, n$$



P352 14 6 $F(s) = \frac{2s + 1}{s^3 + 7s^2 + 10s}$

$s^3 + 7s^2 + 10s = 0$ $p_1 = 0, p_2 = -2, p_3 = -5$

$K_i = \lim_{s \rightarrow p_i} (s - p_i) F(s)$

$K_1 = \lim_{s \rightarrow 0} s F(s) = \lim_{s \rightarrow 0} s \frac{2s + 1}{s^3 + 7s^2 + 10s} = 0.1$

$K_2 = \lim_{s \rightarrow -2} (s + 2) F(s) = \lim_{s \rightarrow -2} (s + 2) \frac{2s + 1}{s(s + 2)(s + 5)} = 0.5$

$K_3 = \lim_{s \rightarrow -5} (s + 5) F(s) = \lim_{s \rightarrow -5} (s + 5) \frac{2s + 1}{s(s + 2)(s + 5)} = -0.6$

$F(s) = \frac{0.1}{s} + \frac{0.5}{s + 2} + \frac{-0.6}{s + 5}$

$f(t) = 0.1 + 0.5e^{-2t} - 0.6e^{-5t}$



$$1 \quad D(s)=0$$
$$p_1=\alpha+j\omega \quad p_2=\alpha-j\omega$$

$$K_1=\frac{N(\alpha+j\omega)}{D'(\alpha+j\omega)} \quad K_2=\frac{N(\alpha-j\omega)}{D'(\alpha-j\omega)}$$

$$F(s) \quad K_1 \quad K_2$$

()

$$K_1=|K_1| e^{j\theta_1} \quad K_2=|K_1| e^{-j\theta_1}$$

$$f(t)=K_1 e^{(\alpha+j\omega)t} + K_2 e^{(\alpha-j\omega)t} = |K_1| e^{j\theta_1} e^{(\alpha+j\omega)t} + |K_1| e^{-j\theta_1} e^{(\alpha-j\omega)t}$$

$$= |K_1| e^{\alpha t} [e^{j(\theta_1+\omega t)} + e^{-j(\theta_1+\omega t)}]$$

$$f(t) = 2|K_1| e^{\alpha t} \cos(\omega t + \theta_1)$$

P353 14 7 $F(s) = \frac{s+3}{s^2+2s+5} \quad f(t)$

$$s^2 + 2s + 5 = 0$$

$$p_1 = -1 + j2 \quad p_2 = -1 - j2 \quad \longrightarrow \quad \alpha = -1 \quad \omega = 2$$

$$K_1 = \frac{N(-1 + j2)}{D'(-1 + j2)} = 0.5 - j0.5 = 0.5\sqrt{2} e^{-j\frac{\pi}{4}}$$

$$|K_1| = 0.5\sqrt{2} \quad \theta_1 = -\frac{\pi}{4}$$

$$f(t) = 2|K_1| e^{\alpha t} \cos(\omega t + \theta_1)$$

$$f(t) = \sqrt{2} e^{-t} \cos\left(2t - \frac{\pi}{4}\right)$$

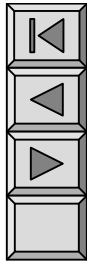

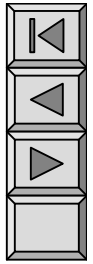

$$D(s) = (s-p_1)^q F(s) \quad (p_1 \text{ is a root of } D(s)=0 \text{ with multiplicity } q)$$

$$F(s) = \frac{K_{11}}{(s-p_1)^q} + \frac{K_{12}}{(s-p_1)^{q-1}} + \dots + \frac{K_{1q}}{s-p_1} + \sum_{i=1}^{n-q} \frac{K_{i+1}}{s-p_{i+1}}$$

$$K_{i+1} \quad K_{11} \sim K_{1q}$$

$$K_{11} = \lim_{s \rightarrow p_1} (s-p_1)^q F(s) \quad K_{12} = \lim_{s \rightarrow p_1} \frac{d}{ds} [(s-p_1)^q F(s)]$$

$$K_{1q} = \frac{1}{(q-1)!} \lim_{s \rightarrow p_1} \frac{d^{q-1}}{ds^{q-1}} [(s-p_1)^q F(s)]$$

$$f(t) = \left[\frac{K_{11}}{(q-1)!} t^{q-1} + \frac{K_{12}}{(q-2)!} t^{q-2} + \dots + K_{1q} \right] e^{p_1 t} + \sum_{i=1}^{n-q} K_{i+1} e^{p_{i+1} t}$$



$$K_{1q} = \frac{1}{(q-1)!} \lim_{s \rightarrow p_1} \frac{d^{q-1}}{ds^{q-1}} [(s-p_1)^q F(s)]$$

P354 14 8 $F(s) = \frac{1}{s^2 (s+1)^3}$

$$(s+1)^3 F(s) = \frac{1}{s^2}$$

$$K_{21} \quad K_{22}$$

$$K_{11} = \lim_{s \rightarrow -1} \frac{1}{s^2} = 1$$

$$s^2 F(s) = \frac{1}{(s+1)^3}$$

$$K_{12} = \lim_{s \rightarrow -1} \frac{d}{ds} \frac{1}{s^2} = 2$$

$$K_{21} = \lim_{s \rightarrow 0} \frac{1}{(s+1)^3} = 1$$

$$K_{13} = \lim_{s \rightarrow -1} \frac{1}{2!} \frac{d^2}{ds^2} \frac{1}{s^2} = 3$$

$$K_{22} = \lim_{s \rightarrow 0} \frac{d}{ds} \frac{1}{(s+1)^3} = -3$$

$$f(t) = \frac{1}{2} t^2 e^{-t} + 2te^{-t} + 3e^{-t} + t - 3$$

§ 14 4

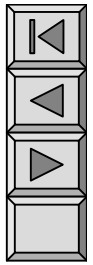

ž



1. KL

KL

KL

$$[i(t)] = [i(t)] = I(s) = 0$$

$$[u(t)] = [u(t)] = U(s) = 0$$

2. VCR

(1) R

$$u(t) = Ri(t)$$

$$U(s) = RI(s)$$

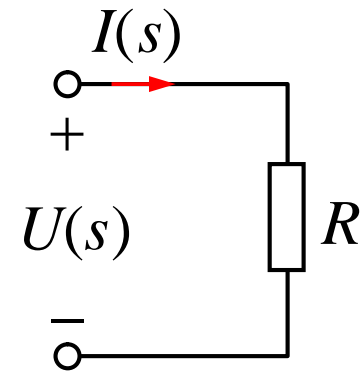
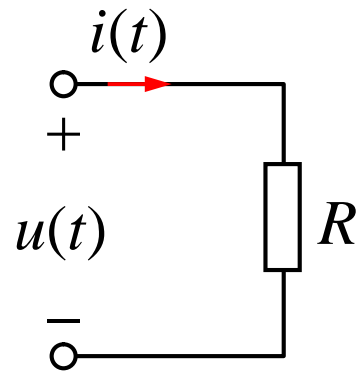

(2) L

$$u(t) = L \frac{di(t)}{dt}$$

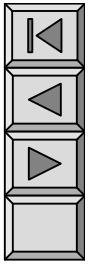
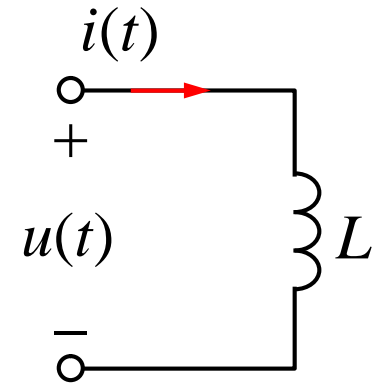

$$U(s) = sLI(s) - Li(0_-)$$

$$I(s) = \frac{1}{sL}U(s) + \frac{i(0_-)}{s}$$

sL L

$1/sL$

$i(0_-)$ L

L

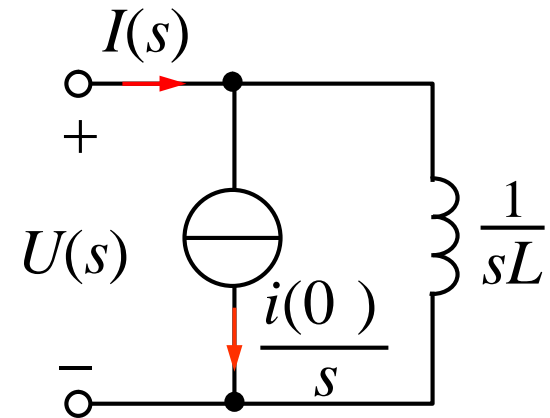
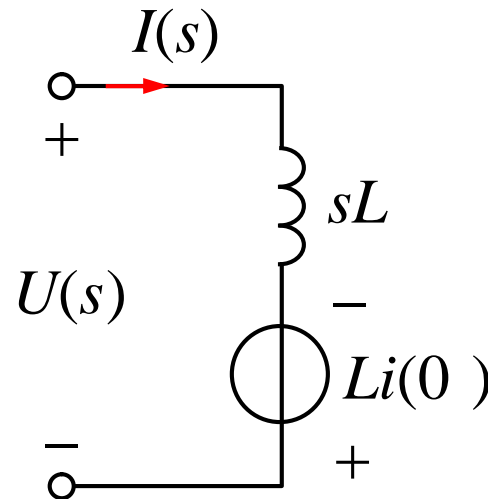

(3) C

$$u(t) = \frac{1}{C} \int_{0_-}^t i(t) dt + u(0_-)$$

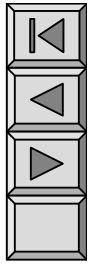
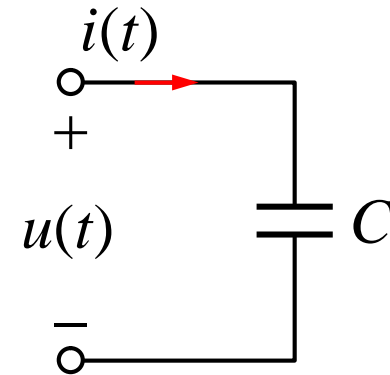

$$U(s) = \frac{1}{sC} I(s) + \frac{u(0_-)}{s}$$

$$I(s) = sCU(s) - Cu(0_-)$$

$1/sC$ C

sC C

$u(0_-)$ C

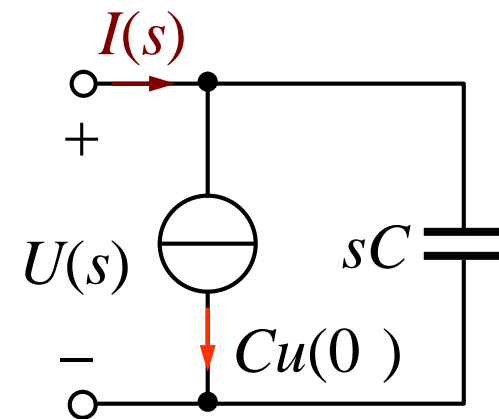
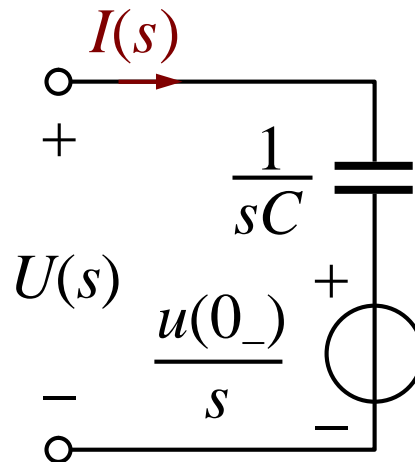



(4)

$$u_1 = L_1 \frac{di_1}{dt} + M \frac{di_2}{dt}$$

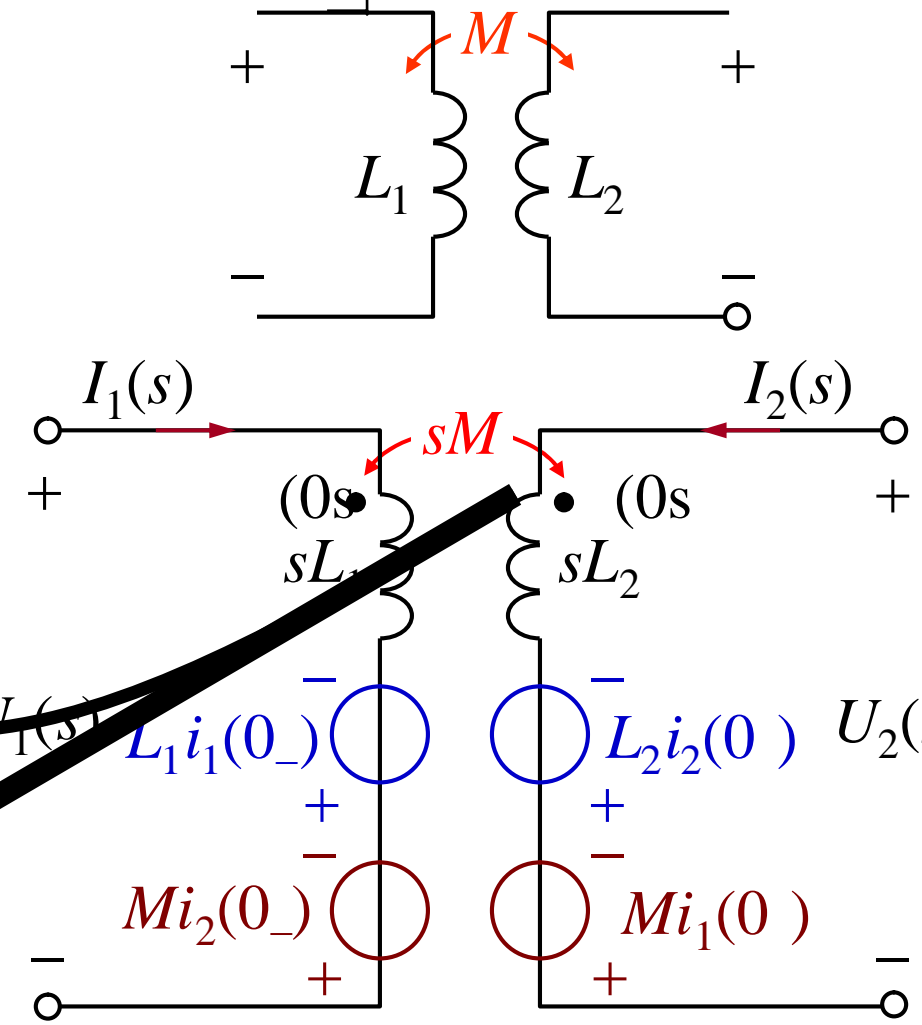

$$U_1(s) = sL_1 I_1(s) - L_1 i_1(0_-) + sM I_2(s) - M i_2(0_-)$$

$$U_2(s) = sL_2 I_2(s) - L_2 i_2(0_-) + sM I_1(s) - M i_1(0_-)$$



(5)

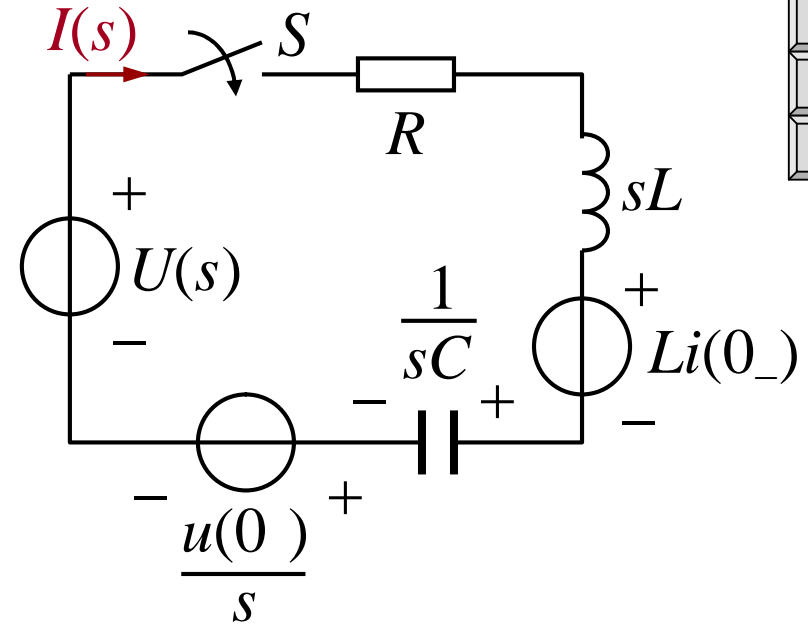
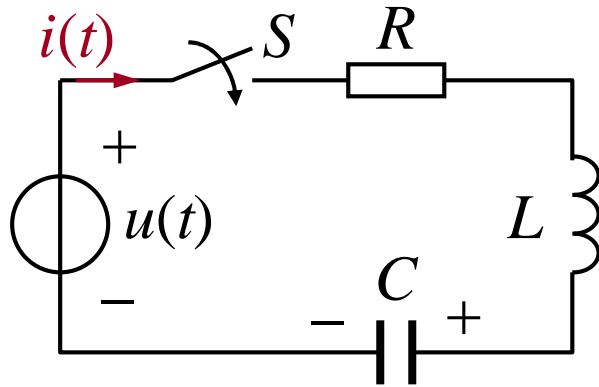

$$u(0)$$

$$i(0)$$

$$u = Ri + L \frac{di}{dt} + \frac{1}{C} \int_{0_-}^t i dt$$

$$U(s) = RI(s) + sLI(s) - Li(0_-) + \frac{1}{sC} I(s) - \frac{u(0)}{s}$$

$$(R + sL + \frac{1}{sC}) I(s) =$$

§ 14 5

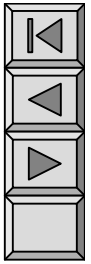

i $I(s)$ u $U(s)$ R $Z(s)$ G $Y(s)$

()

P359 14 9

$t=0$ S $i_1(t)$

$$i_L(0_-) = 0 \quad U_C(0_-) = U_S = 1V$$

$$[U_S] = [1] = 1/s$$

$$\left. \begin{aligned} \left(1+s+\frac{1}{s}\right) I_a(s) - \frac{1}{s} I_b(s) &= 0 \\ -\frac{1}{s} I_a(s) + \left(1+\frac{1}{s}\right) I_b(s) &= \frac{1}{s} \end{aligned} \right\}$$

$$I_1(s) = I_a(s) = \frac{1}{s(s^2+2s+2)}$$

$$[I_1(s)] = \frac{1}{2} (1 + e^{-t} \cos t - e^{-t} \sin t) \text{ A}$$

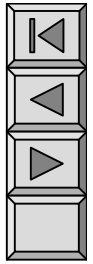
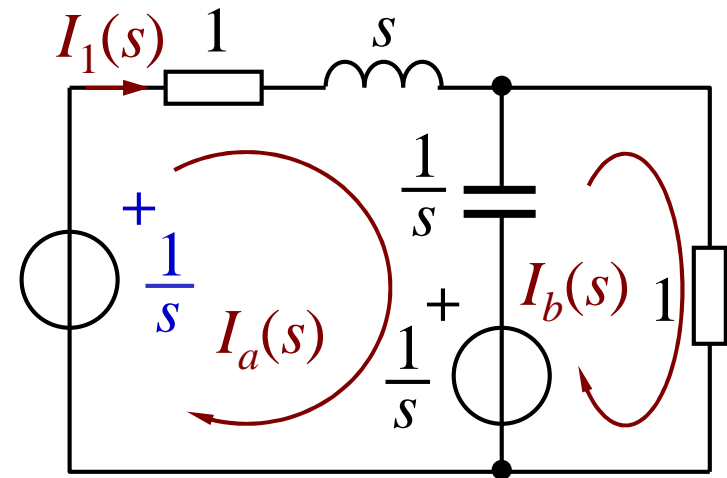
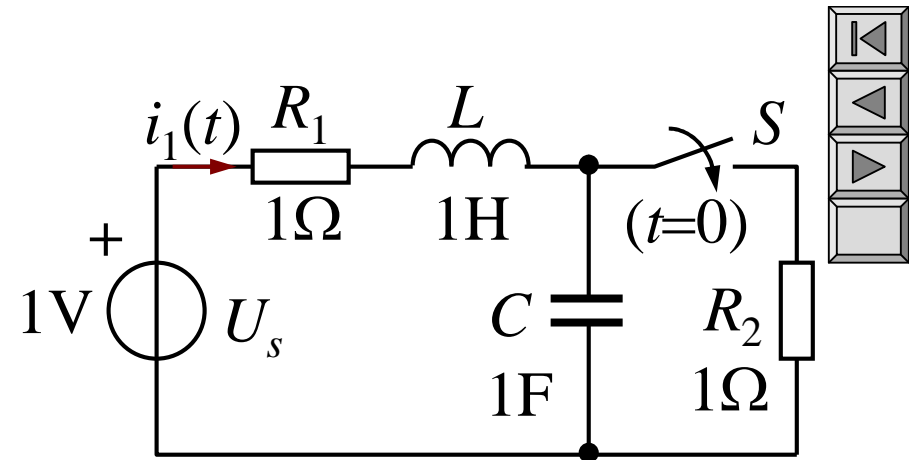

P361 14 11

S $t = 0$ $u_L(t)$

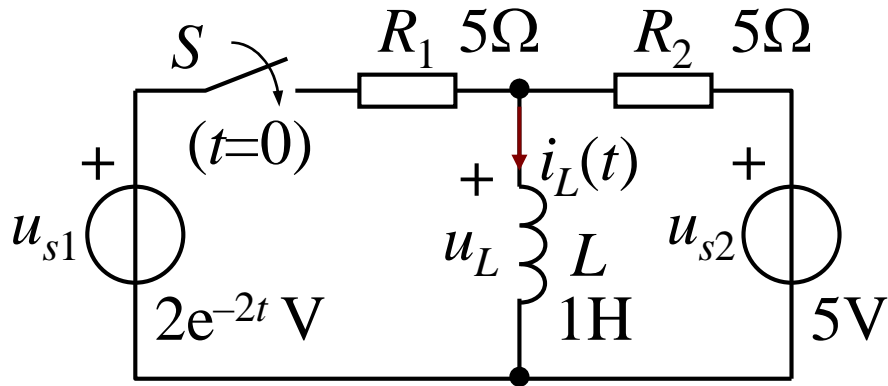
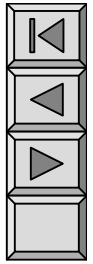

$$i_L(0) = \frac{u_{s2}}{R_2} = 1 \text{ A}$$

$$[2e^{-2t}] = \frac{2}{s+2} \quad [5] = \frac{5}{s}$$

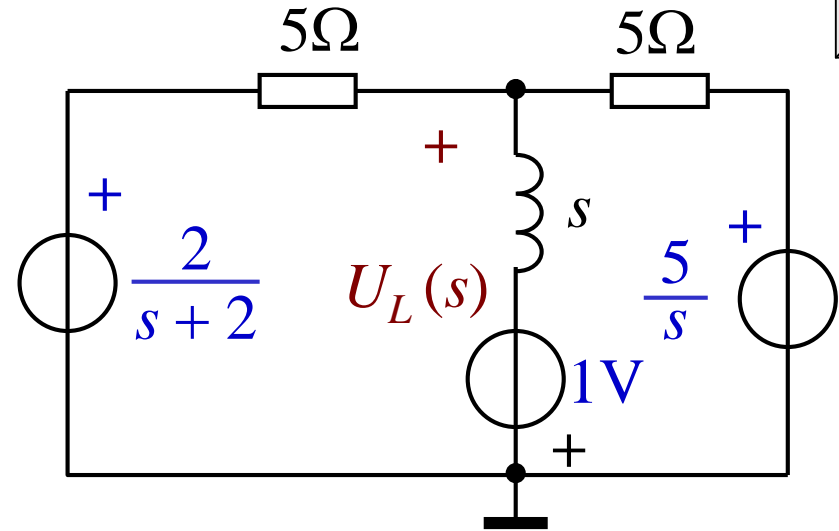

$$U_L(s) = U_{n1}(s) = \frac{2s}{(s+2)(2s+5)}$$

$$\left[\frac{1}{5} + \frac{1}{5} + \frac{1}{s} \right] U_{n1}(s) = \frac{2}{5(s+2)} - \frac{1}{s} + \frac{5}{5}$$

$$\frac{2s+5}{5s} U_{n1}(s) = \frac{2}{5(s+2)}$$

$$[U_L(s)] = (-4e^{-2t} + 5e^{-2.5t}) \text{ V}$$



P362 14 12 S

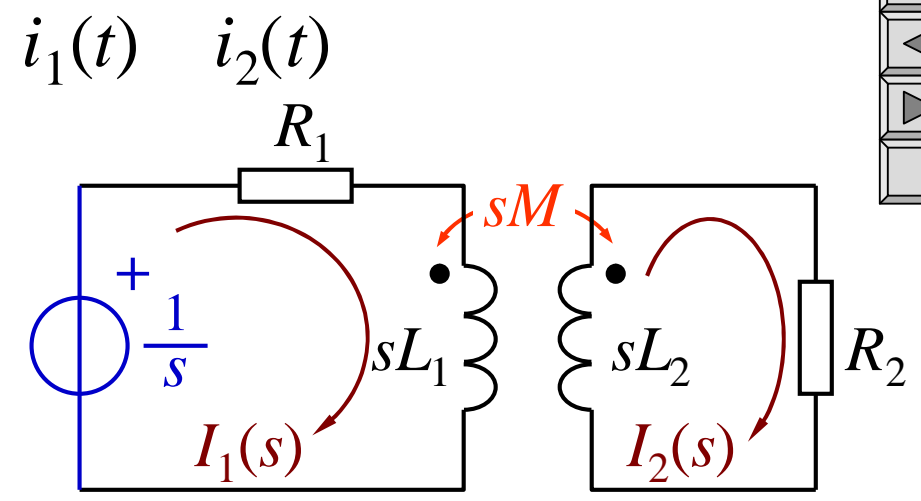
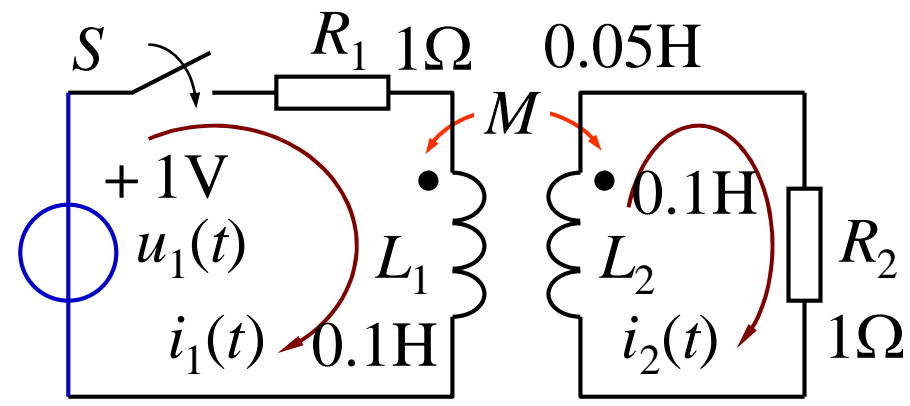

$$(R_1 + sL_1)I_1(s) - sMI_2(s) = (1/s)$$

$$-sMI_1(s) + (R_2 + sL_2)I_2(s) = 0$$

$$(1 + 0.1s)I_1(s) - 0.05sI_2(s) = (1/s)$$

$$-0.05sI_1(s) + (1 + 0.1s)I_2(s) = 0$$

$$I_1(s) = \frac{0.1s + 1}{s(7.5 \times 10^3 s^2 + 0.2s + 1)}$$

$$I_2(s) = \frac{0.05}{s(7.5 \times 10^3 s^2 + 0.2s + 1)}$$

$$i_1(t) = (1 - 0.5e^{-6.67t} - 0.5e^{-20t})A$$

$$i_2(t) = 0.5(0.5e^{-6.67t} - e^{-20t})A$$

P363 14 13

S

$i(t)$

$$[10] = (10/s)$$

$$i_{L1}(0^-) = 5A \quad L_1 i_{L1}(0^-) = 1.5V$$

$$I(s) = \frac{\frac{10}{s} + 1.5}{2 + 3 + (0.3 + 0.1)s} = \frac{(1.5s + 10)}{s(0.4s + 5)} = \frac{2}{s} + \frac{1.75}{s + 12.5}$$

$$i(t) = (2 + 1.75e^{-12.5t}) A$$

$$U_{L1}(s) = 0.3sI(s) - 1.5 = -\frac{6.56}{s + 12.5} - 0.375$$

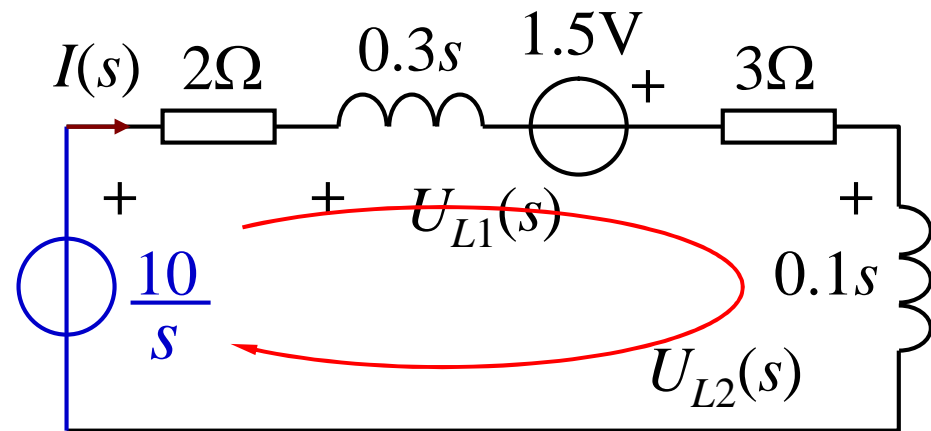
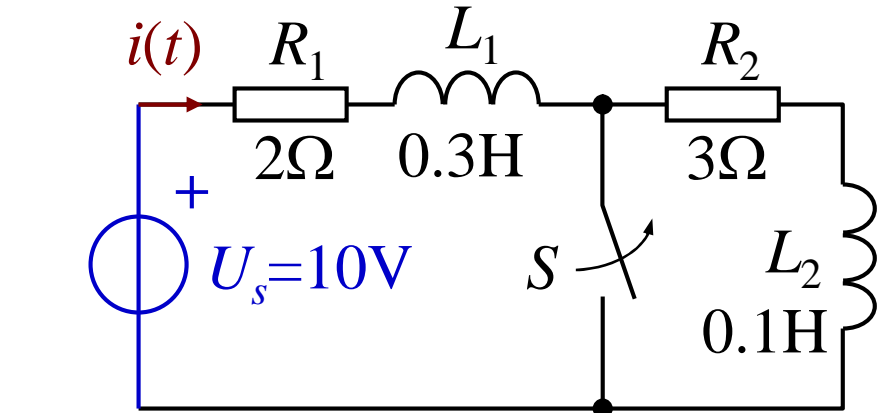

$$U_{L2}(s) = 0.1sI(s) = -\frac{2.19}{s + 12.5} - 0.375$$

$$u_{L1}(t) = [-6.56e^{-12.5t} - 0.375\delta(t)] V$$

$$u_{L2}(t) = [-2.19e^{-12.5t} + 0.375\delta(t)] V$$

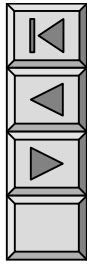

$$i_{L1}(0^-) = 5\text{A}$$

$$i(t) = (2 + 1.75e^{12.5t})\text{A}$$

$$u_{L1}(t) = [-6.56e^{12.5t} - 0.375\delta(t)]\text{V}$$

$$u_{L2}(t) = [-2.19e^{12.5t} + 0.375\delta(t)]\text{V}$$

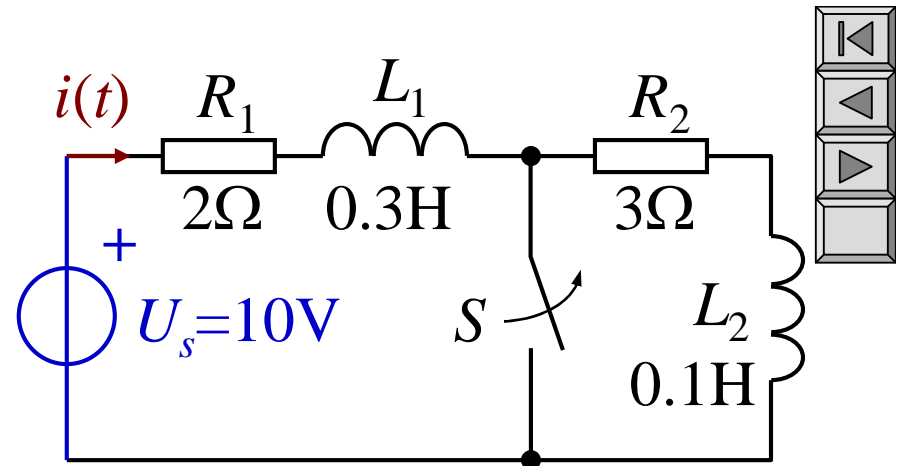

S

$$i_{L1}(0_+) = 3.75\text{A}$$

$$u_{L1}(t)$$

$$u_{L2}(t)$$

$$u_{L1}(t) + u_{L2}(t)$$

KVL

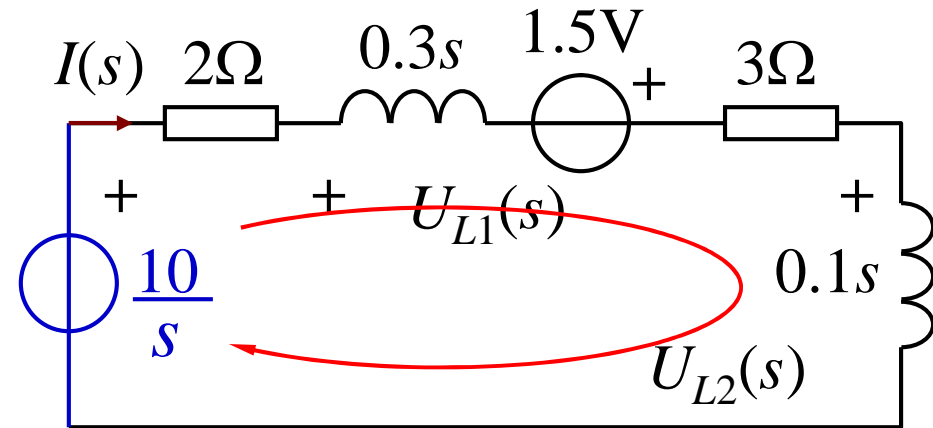

$$i_L(t) \quad u_C(t)$$

$$i_{L1}(0^-) = 5A$$

$$i(t) = (2 + 1.75e^{12.5t})A$$

$$u_{L1}(t) = [-6.56e^{12.5t} - 0.375\delta(t)]V$$

$$u_{L2}(t) = [-2.19e^{12.5t} + 0.375\delta(t)]V$$

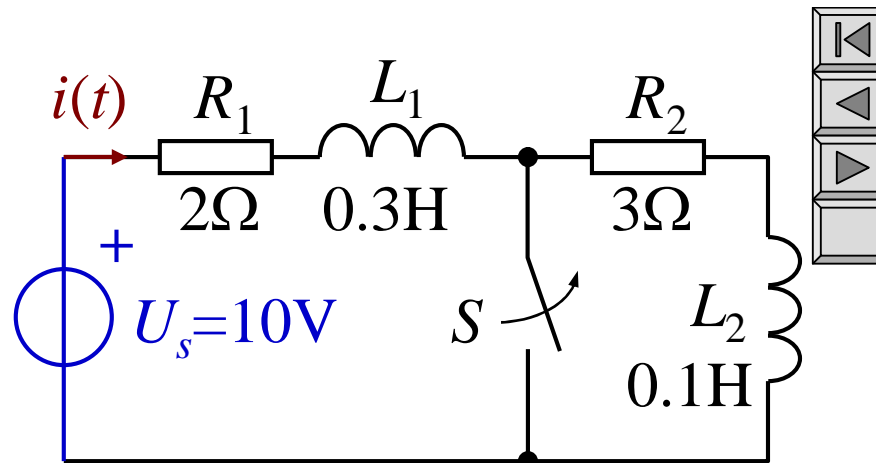

$$i(t)$$

$$i(t)$$

$$u_{L1}(t) \quad u_{L2}(t)$$

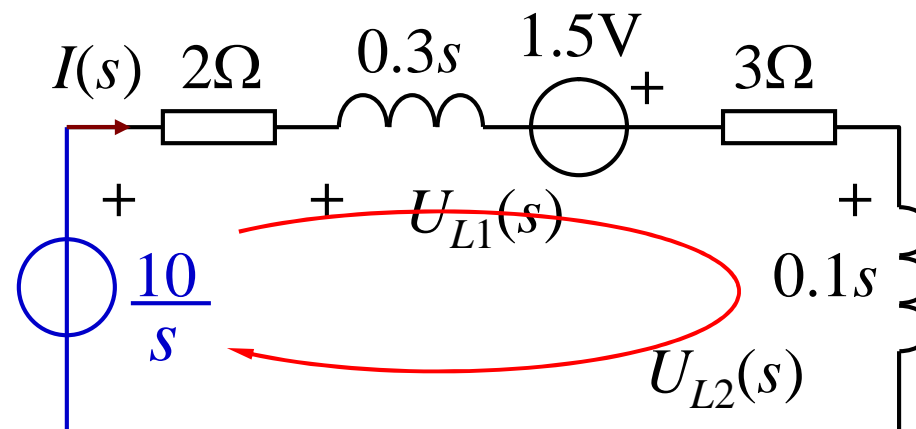

$$\varepsilon(t)$$

$$t < 0$$

$$0$$

$$\varepsilon(t)$$

$$0$$

$$\varepsilon(t)$$

$$L_1 i_{L_1}(0^-) + L_2 i_{L_2}(0^-) = (L_1 + L_2) i(0^-)$$

$$i(0^-) = \underline{\hspace{10em}}$$

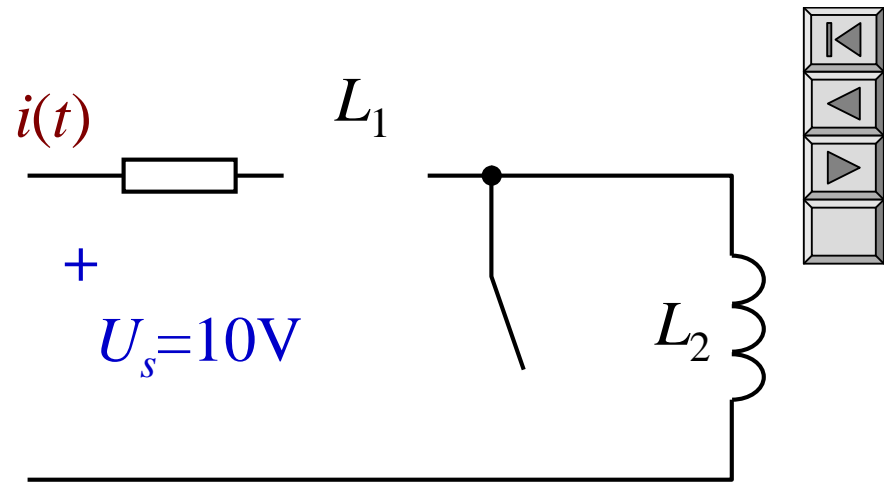

$$i(0_-) = i_{L_1}(0_-) = 5\text{A}$$

$$i(t) = 2 + (3.75 - 2)e^{-12.5t} \text{ A}$$

$t \geq 0$

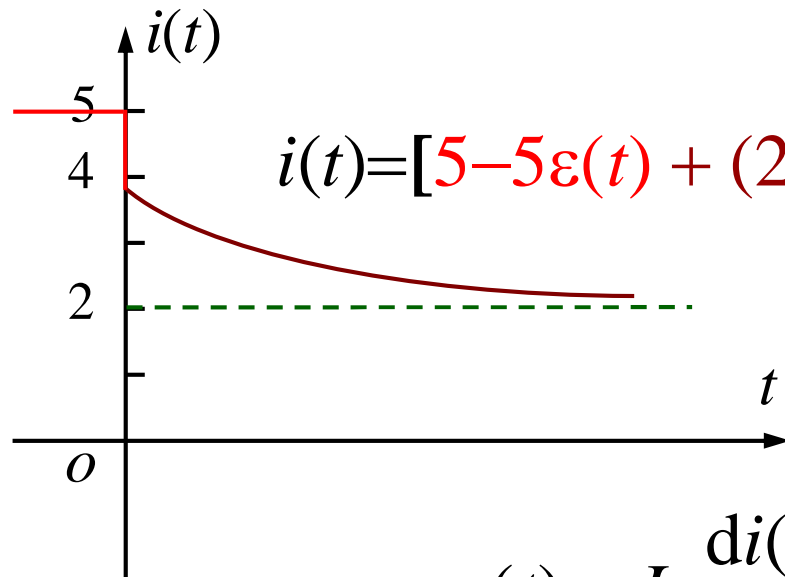
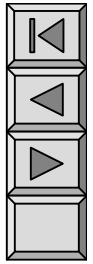
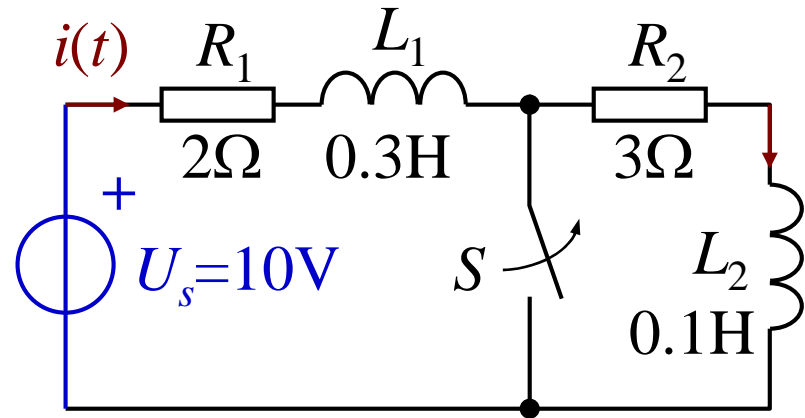

$$i(t) = [5 - 5\varepsilon(t) + (2 + 1.75e^{-12.5t})\varepsilon(t)] \text{ A} \quad (t \geq 0)$$

$$u_{L_1}(t) = L_1 \frac{di(t)}{dt} = [-6.56e^{-12.5t} - 0.375\delta(t)] \text{ V}$$

§ 14 6

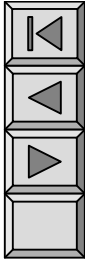

1.

$$R(s) \quad e(t) \quad E(s) \quad r(t)$$

$$H(s) \quad R(s) \quad E(s)$$

$$H(s) \stackrel{\text{def}}{=} \frac{R(s)}{E(s)}$$

2.

$$E(s) \quad R(s) \quad H(s)$$

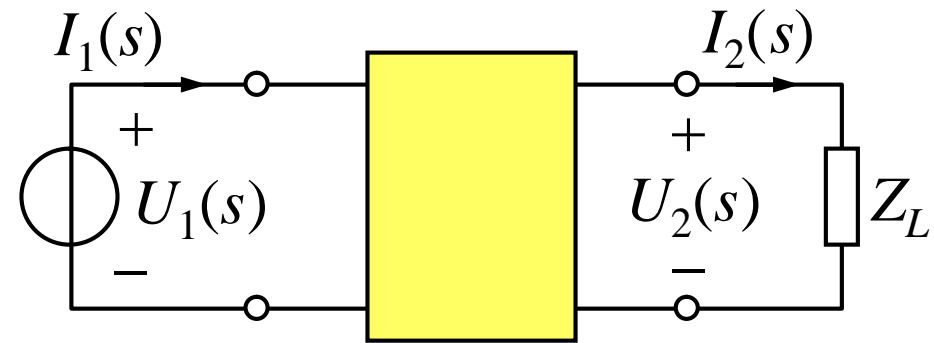



$$E(s) = 1, \quad e(t) = \delta(t)$$

$$R(s) = H(s)E(s) = H(s)$$

$$h(t) = \mathcal{L}^{-1}[H(s)] = \mathcal{L}^{-1}[R(s)] = r(t)$$

$h(t)$

$H(s)$

$E(s)$

$R(s)$

$$R(s) = H(s)E(s)$$

P366 14-15

$$i_s = \delta(t)$$

$$h(t) = u_c(t)$$

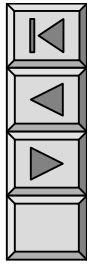
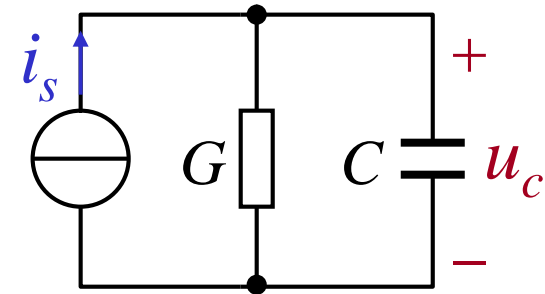

$$H(s) = \frac{R(s)}{E(s)} = \frac{U_c(s)}{I_s(s)} = Z(s)$$

$$Z(s) = \frac{1}{G + sC} = \frac{1}{C} \frac{1}{s + \frac{1}{RC}}$$

$$h(t) = u_c(t) = \mathcal{L}^{-1}[H(s)] = \frac{1}{C} e^{-\frac{t}{RC}} \varepsilon(t)$$

P366 14 16

$u_1(t)$

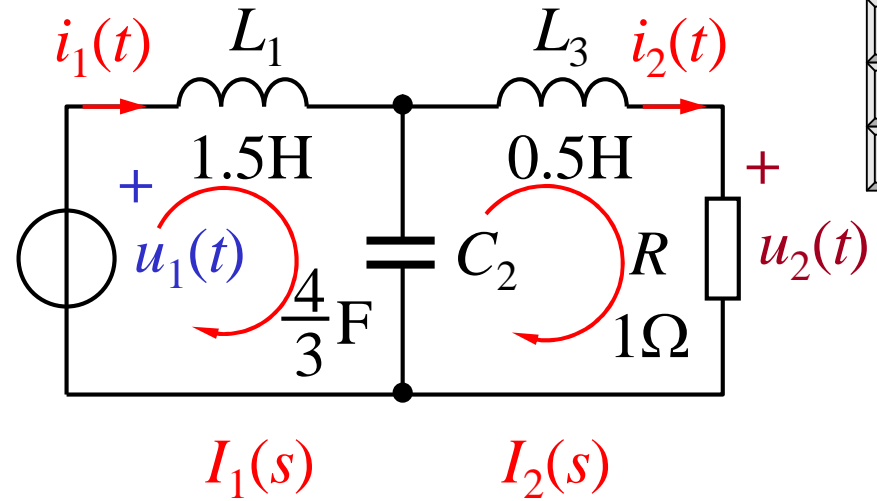

$$(sL_1 + \frac{1}{sC_2})I_1(s) - \frac{1}{sC_2}I_2(s) = U_1(s)$$

$$-\frac{1}{sC_2}I_1(s) + (sL_3 + \frac{1}{sC_2} + R)I_2(s) = 0$$

$$I_1(s) = \frac{L_3C_2s^2 + RC_2s + 1}{D(s)} U_1(s) \quad I_2(s) = \frac{1}{D(s)} U_1(s)$$



$$I_1(s) = \frac{L_3 C_2 s^2 + R C_2 s + 1}{D(s)} U_1(s)$$

$$I_2(s) = \frac{1}{D(s)} U_1(s)$$

$$D(s) = L_1 L_3 C_2 s^3 + R L_1 C_2 s^2 + (L_1 + L_2) s + R$$

$$D(s) = s^3 + 2s^2 + 2s + 1$$

§ 14 7

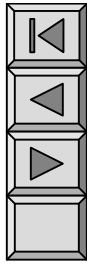

 $H(s)$
 $H(s)$

(\quad)
 $H(s)$

 R
 $L(M)$
 C

$H(s)$
 s

(\quad)

1. $H(s)$

$$H(s) = \frac{N(s)}{D(s)} = \frac{b_m s^m + b_{m-1} s^{m-1} + \dots + b_0}{a_n s^n + a_{n-1} s^{n-1} + \dots + a_0}$$



$$H(s) = \frac{N(s)}{D(s)} = H_0 \frac{(s-z_1)(s-z_2) \cdots (s-z_i) \cdots (s-z_m)}{(s-p_1)(s-p_2) \cdots (s-p_j) \cdots (s-p_n)}$$

$$= H_0 \frac{\prod_{i=1}^m (s-z_i)}{\prod_{j=1}^n (s-p_j)} \quad H_0$$

$$z_1 \quad z_2 \quad \cdots \quad z_m \quad N(s) = 0$$

$$s=z_i \quad H(s)=0$$

$$p_1 \quad p_2 \quad \cdots \quad p_m \quad D(s) = 0$$

$$s=p_i \quad H(s)$$

2.

s
“ ”

$H(s)$

“ × ”

$$H(s) = \frac{2s^2 - 12s + 16}{s^3 + 4s^2 + 6s + 3}$$

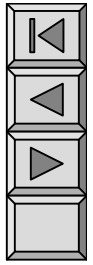
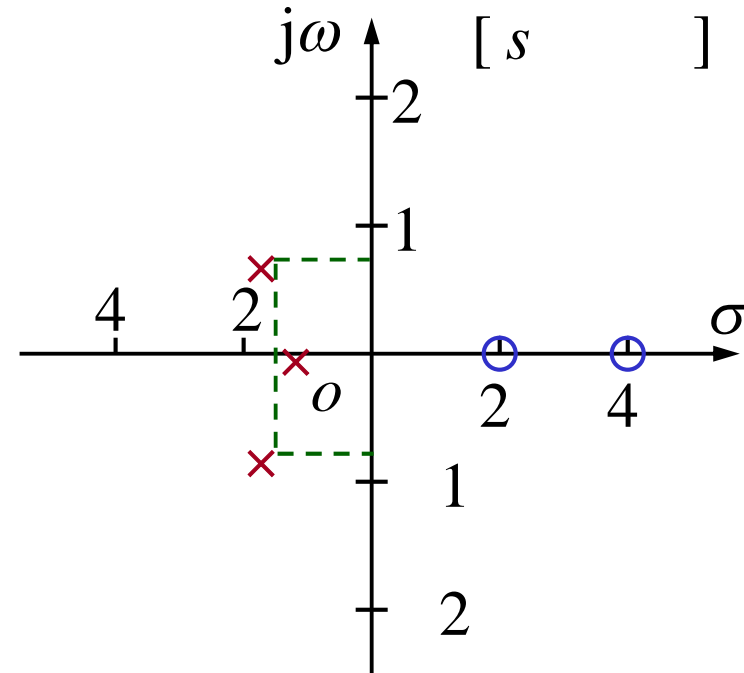

$$2(s^2 - 6s + 8) = 2(s - 2)(s - 4)$$

$$(s + 1)(s^2 - 3s + 3)$$

$$= (s + 1) \left(s + \frac{3}{2} + j\frac{\sqrt{3}}{2} \right) \left(s + \frac{3}{2} - j\frac{\sqrt{3}}{2} \right)$$

§ 14 8

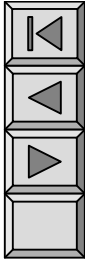

$H(s)$

$$R(s) = H(s) E(s) = \frac{N(s)}{D(s)} \frac{P(s)}{Q(s)}$$

$$H(s) E(s) \quad s \quad D(s)Q(s)=0$$

$$D(s)=0 \quad Q(s)=0$$

$$Q(s)=0$$

$$D(s)=0 \quad (\quad)$$

$h(t)$



$H(s)$

$D(s)=0$

$$h(t) = \mathcal{L}^{-1}[H(s)] = \mathcal{L}^{-1} \left[\sum_{i=1}^n \frac{K_i}{s - p_i} \right] = \sum_{i=1}^n K_i e^{p_i t}$$

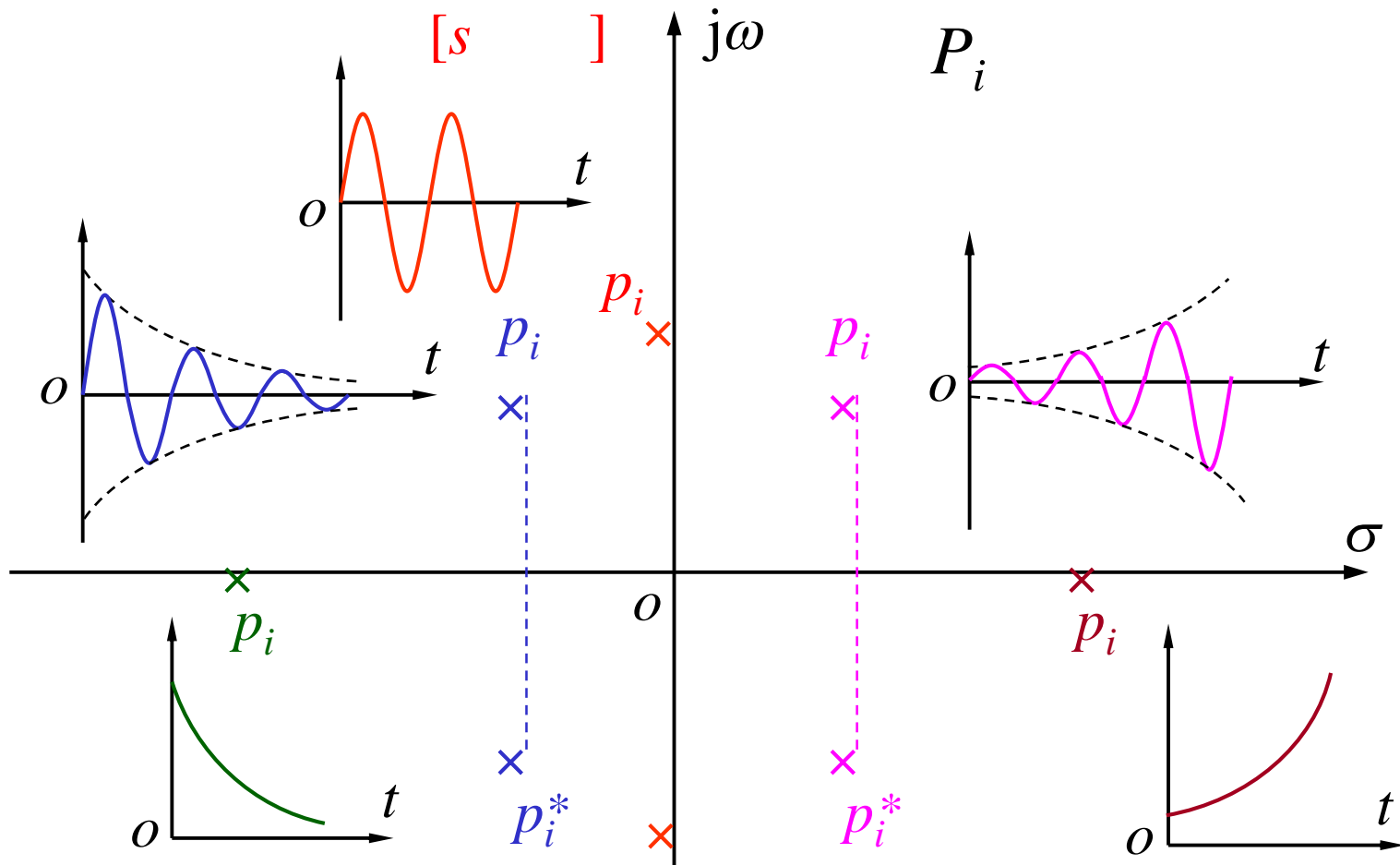

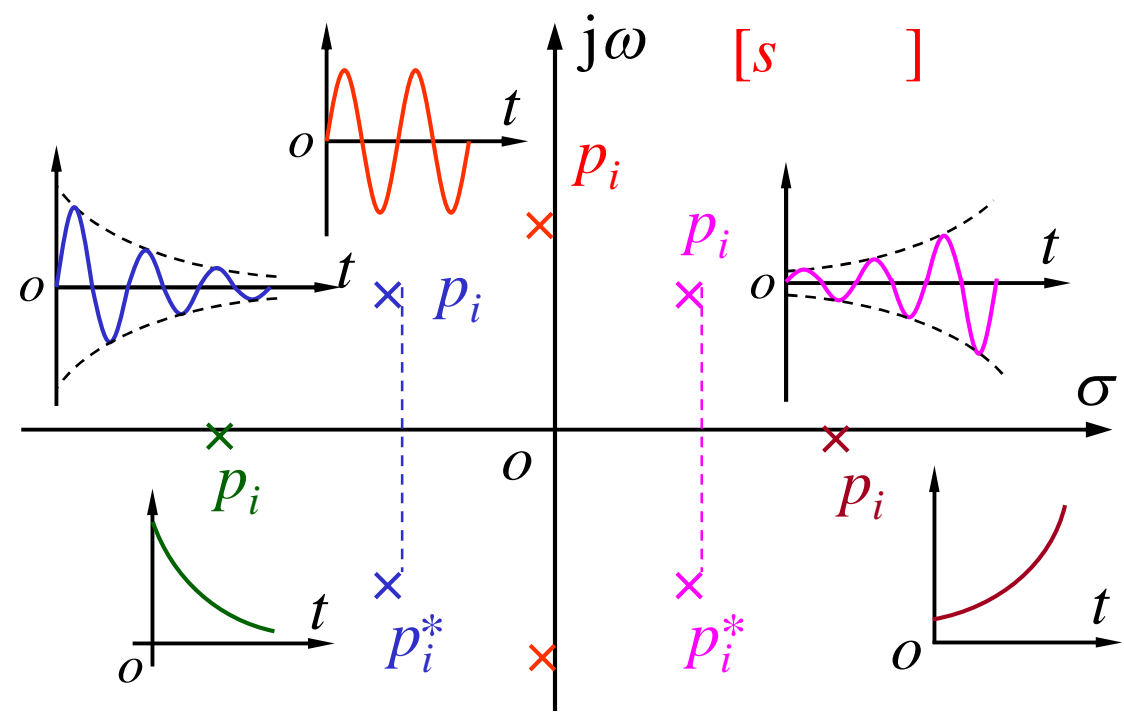

(s)

(s)

()

P371 14 18

$$H(s)$$

$$u_C(t)$$

$$U_S(s)$$

$$U_C(s)$$

$$H(s) = U_C(s)/U_S(s)$$

$$U_C(s) = I(s) \frac{1}{sC} = \frac{U_S(s)}{R + sL + \frac{1}{sC}} \frac{1}{sC} = \frac{U_S(s)}{s^2LC + sRC + 1}$$

$$H(s) = \frac{1}{LC} \frac{1}{(s-p_1)(s-p_2)} \quad p_1 = -\frac{R}{2L} + \sqrt{\left(\frac{R}{2L}\right)^2 - \frac{1}{LC}}$$

$$p_1 \quad p_2 \quad p_2 = -\frac{R}{2L} - \sqrt{\left(\frac{R}{2L}\right)^2 - \frac{1}{LC}}$$

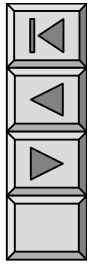
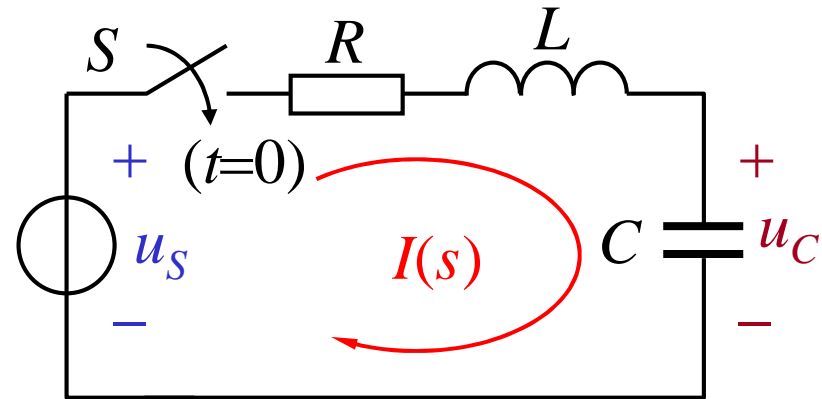



(1) $0 <$

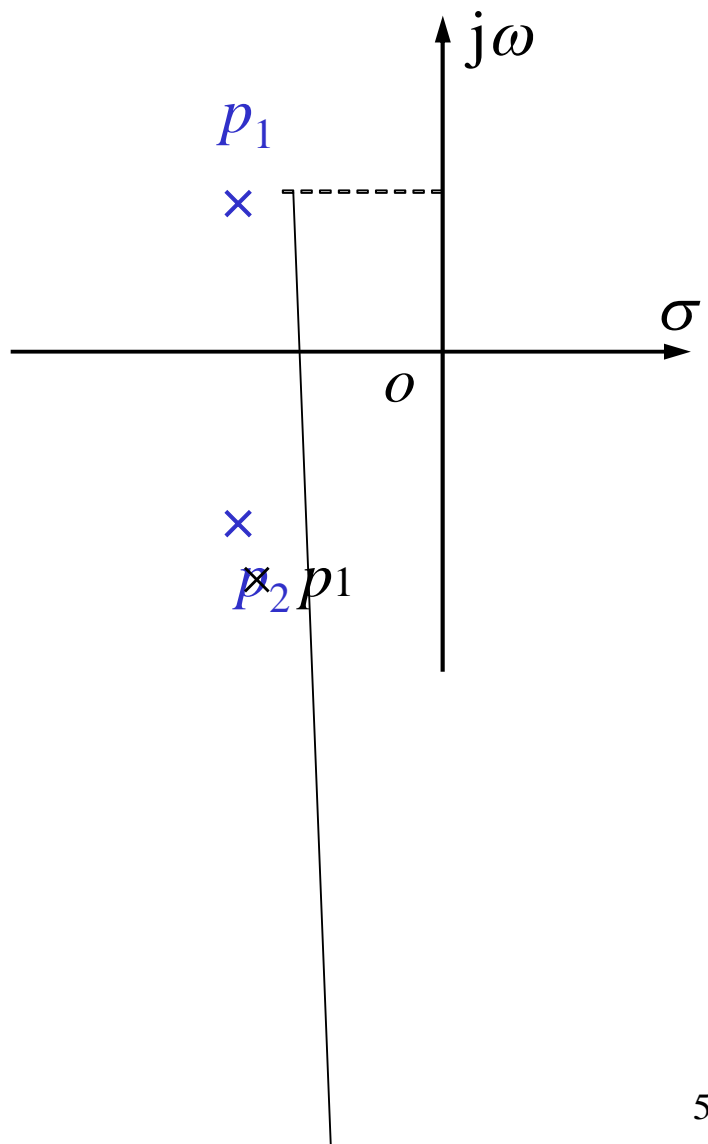

$$p_1 = -\frac{R}{2L} + \sqrt{\left(\frac{R}{2L}\right)^2 - \frac{1}{LC}} \quad p_2 = -\frac{R}{2L} - \sqrt{\left(\frac{R}{2L}\right)^2 - \frac{1}{LC}}$$

$$\delta = \frac{R}{2L} \quad \omega_0 = \frac{1}{\sqrt{LC}} \quad \omega_d = \sqrt{\delta^2 + \omega_0^2}$$

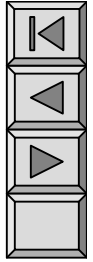

$$(3) R > 2\sqrt{\frac{L}{C}}$$

$p_1 \quad p_2$

$u_C(t)$

$u_C(t)$

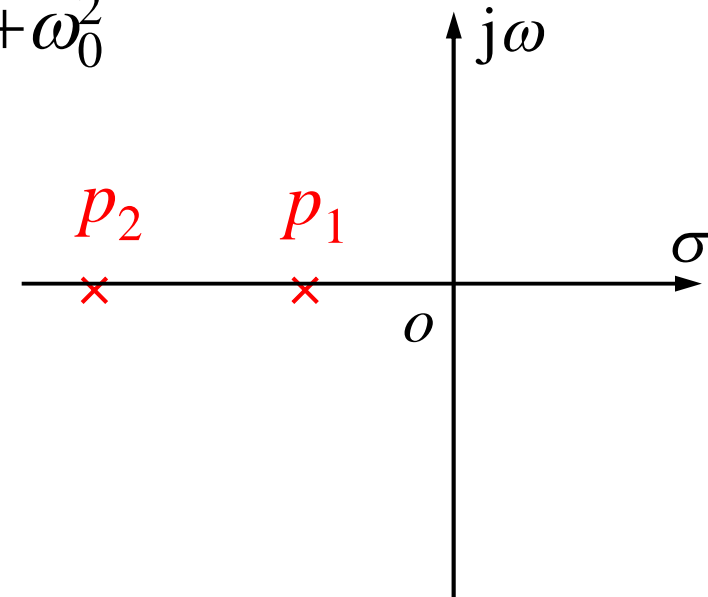

$H(s)$

$u_C(t)$

§ 14 9

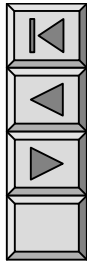

$$H(s) \quad s=j\omega \quad H(j\omega) \quad \omega$$

$$\omega \quad H(j\omega)$$

$$H(j\omega) = |H(j\omega)| \underline{\varphi(j\omega)}$$

$$|H(j\omega)| \quad \omega \quad |H(j\omega)| \quad \omega$$

$$\varphi(j\omega)$$

$$H(j\omega) = H_0 \frac{\prod_{i=1}^m (j\omega - z_i)}{\prod_{j=1}^n (j\omega - p_j)}$$



$$|H(j\omega)| = H_0 \frac{\prod_{i=1}^m |(j\omega - z_i)|}{\prod_{j=1}^n |(j\omega - p_j)|} \quad (1)$$

$$\varphi(j\omega) = \sum_{i=1}^m \arg(j\omega - z_i) \quad (2)$$

$$- \sum_{j=1}^n \arg(j\omega - p_j)$$

$$= \sum_{i=1}^m \varphi_i - \sum_{i=1}^n \theta_i$$

Bode

14 19

RC

$$(1) \quad H(j\omega) = \frac{\dot{U}_2(j\omega)}{\dot{U}_1(j\omega)} = \frac{\frac{1}{RC}}{j\omega + \frac{1}{RC}}$$

$$|H(j\omega)| = \frac{H_0}{\left| j\omega + \frac{1}{RC} \right|}$$

$$\varphi(j\omega) = 0 - \theta(j\omega) = -\arctg(\omega RC)$$

(2)

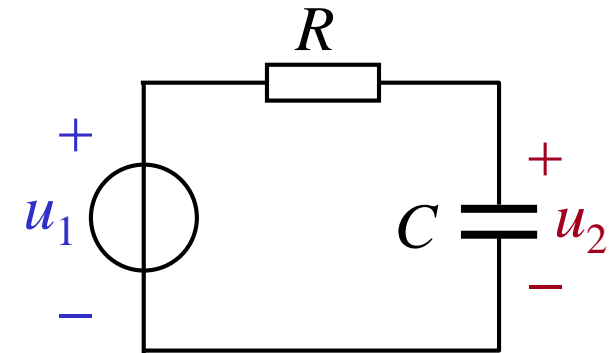

$$\omega=0 \quad |H(j0)|=1$$

$$\varphi(j0)=0$$

$$\omega = \omega_c = \frac{1}{RC}$$

$$|H(j\omega_c)| = \frac{1}{\sqrt{2}}$$

$$\varphi(j\omega_c) = 45^\circ$$

$$\omega \quad |H(j \quad)|=0$$

$$\varphi(j \quad) = 90^\circ$$

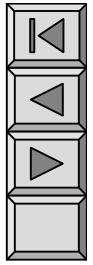



$$|H(j\omega)| = \frac{H_0}{\left|j\omega + \frac{1}{RC}\right|} = \frac{H_0}{M(\omega)}$$

$$\varphi(j\omega) = -\theta(\omega) = -\arctg(\omega RC)$$

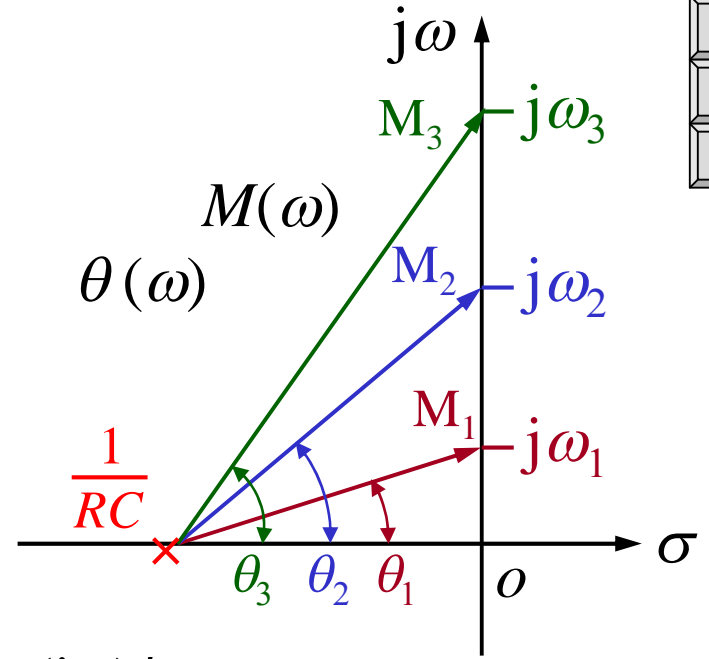

$$\omega = \omega_1 \quad |H(j\omega_1)| = H_0/M_1$$

$$\varphi(j\omega_1) = -\theta_1$$

$$\omega = \omega_2 \quad |H(j\omega_2)| = H_0/M_2$$

$$\varphi(j\omega_2) = -\theta_2$$

$$\omega = \omega_3 \quad |H(j\omega_3)| = H_0/M_3$$

$$\varphi(j\omega_3) = -\theta_3$$

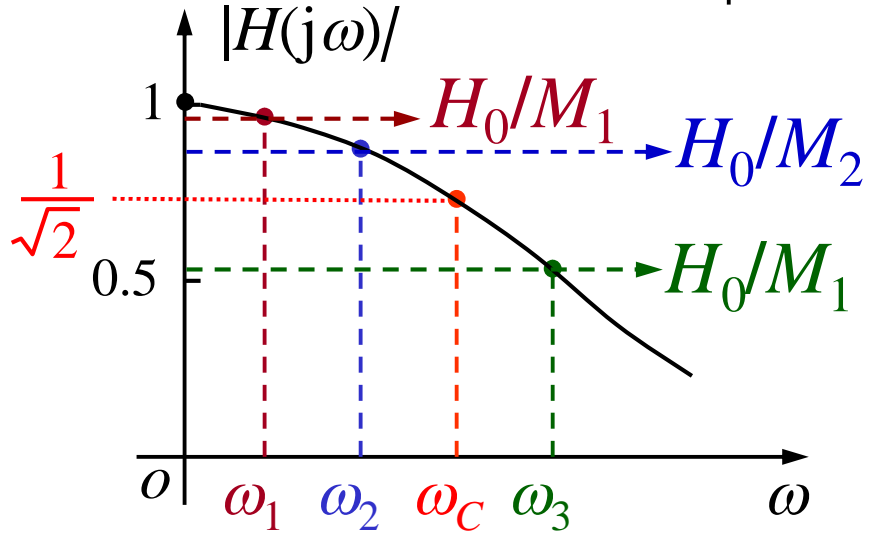



ω_C

$$\omega_C - 0 = \omega_C$$

$$\omega_C = \frac{1}{RC}$$

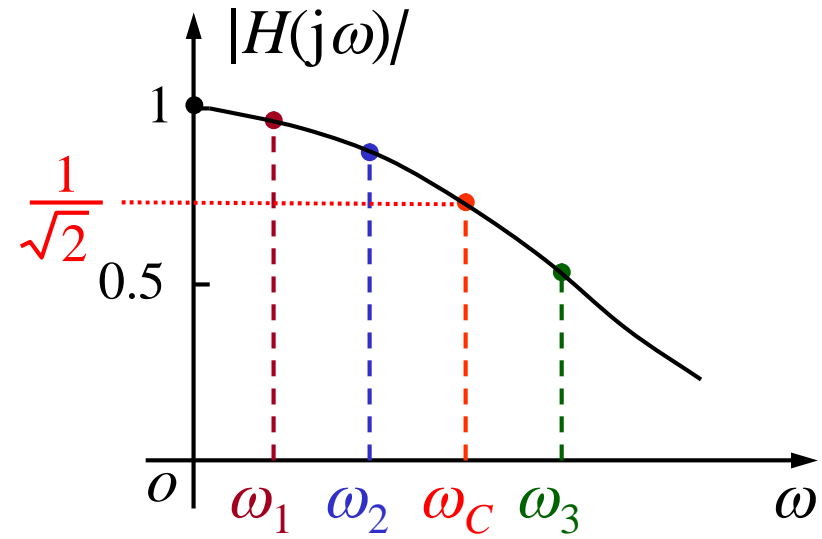

$M(\omega)$

$\theta(\omega)$

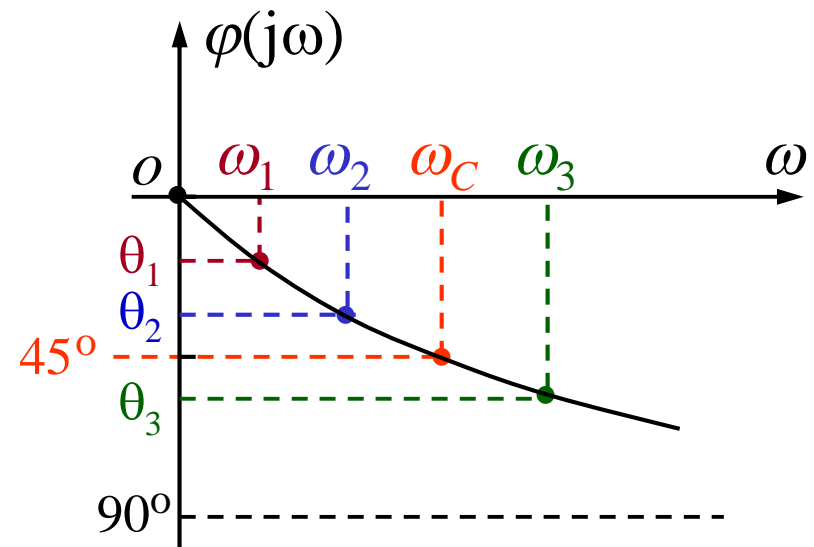

14 20 RLC

$$H(s) = \frac{U_2(s)}{U_1(s)},$$

$H(j\omega)$

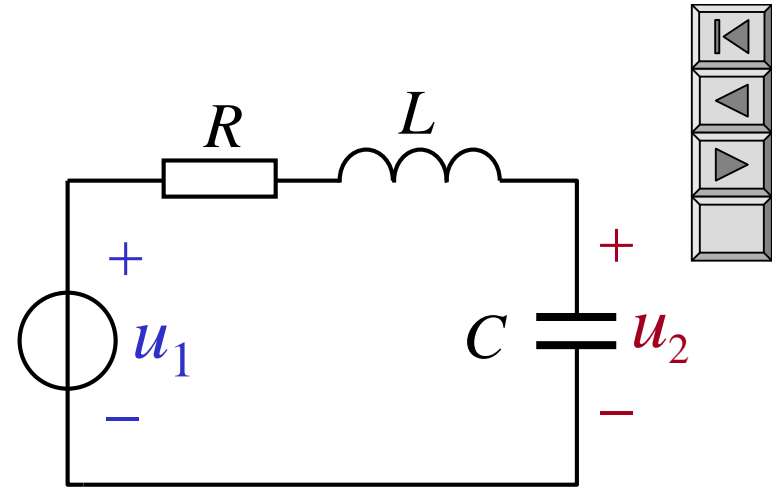

P371 14 18

$$H(s) = \frac{1}{LC} \frac{1}{(s-p_1)(s-p_2)} = \frac{H_0}{(s-p_1)(s-p_2)}$$

$s=j\omega$

$$H(j\omega) = \frac{H_0}{(j\omega-p_1)(j\omega-p_2)}$$

$$p_{1,2} = -\frac{R}{2L} \pm \sqrt{\left(\frac{R}{2L}\right)^2 - \frac{1}{LC}}$$



$$p_1 = -\delta + j\omega_d \quad p_2 = -\delta - j\omega_d$$

$\delta \quad \omega_d \quad \omega_0$

$$|H(j\omega)| = \frac{H_0}{|j\omega - p_1| |j\omega - p_2|} = \frac{H_0}{M_1(\omega) M_2(\omega)}$$

$$\varphi(j\omega) = -(\theta_1 + \theta_2)$$

$$\omega = \omega_1 \quad |H(j\omega_1)| = \frac{H_0}{M_1 M_2}$$

$$\varphi(j\omega_1) = -(-\theta_1 \quad \theta_2)$$

$\omega = \omega_2 \quad \dots$

14-19

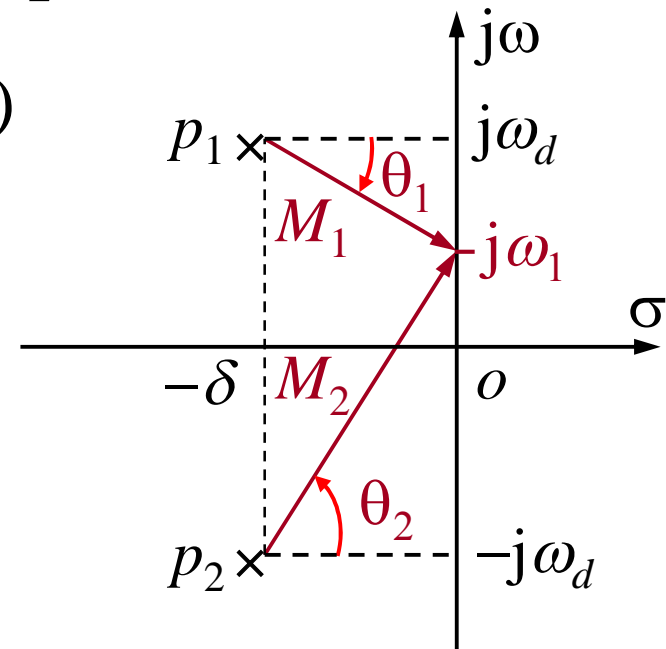



$$|H(j\omega_1)| = \frac{N_1}{M_1 M_2 M_3 M_4}$$

$$|\varphi(j\omega_1)| = \varphi_1 - (\theta_1 + \theta_2 + \theta_3 + \theta_4)$$

5

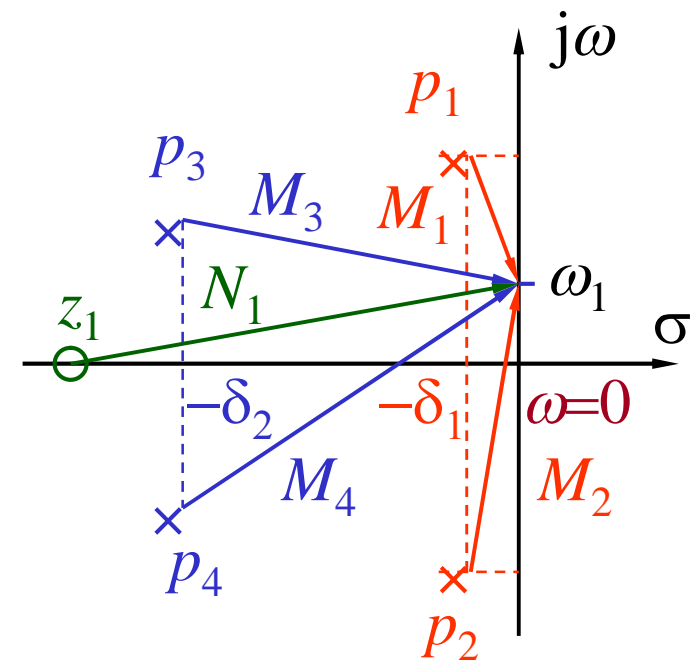

ω M_1 M_2 θ_1 θ_2
 M_1 θ_1

$$Q_p \stackrel{\text{def}}{=} \frac{1}{2} \frac{\sqrt{\delta^2 + \omega_d^2}}{\delta} = \frac{\omega_0}{2\delta}$$

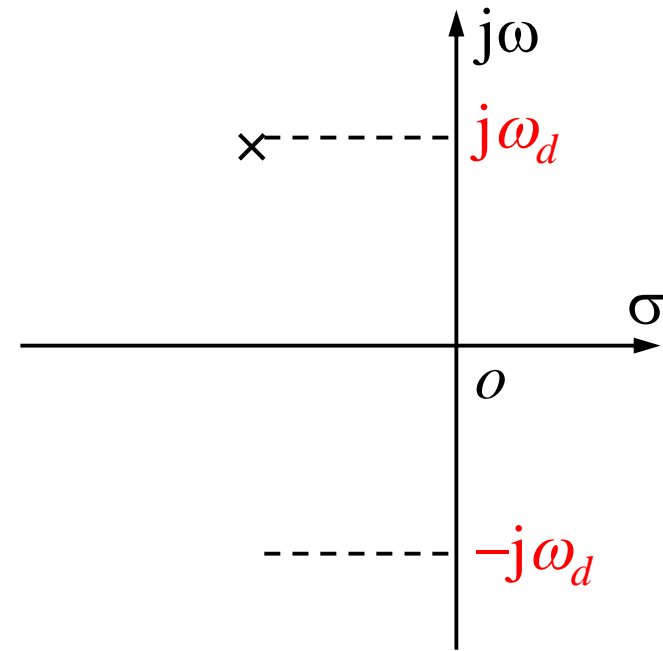

§ 7 9

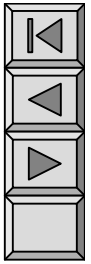

$$f_1(t) \quad f_2(t)$$

$$f_1(\xi) f_2(t - \xi) d\xi$$

$$f_1(t) \quad f_2(t)$$

$$f_1(t) * f_2(t)$$

$$f_1(t) * f_2(t) = f_2(t) * f_1(t)$$

$$f_1(t) * [f_2(t) + f_3(t)] = f_1(t) * f_2(t) + f_1(t) * f_3(t)$$



$$f_1(t) = \varepsilon(t) \quad f_2(t) = \begin{cases} 0 & t < 0 \\ e^{-t} & t \geq 0 \end{cases}$$

$$f_1(t) * f_2(t)$$

$$f_1(t) * f_2(t) = \int_{-\infty}^{\infty} f_1(\xi) f_2(t - \xi) d\xi$$

$$f_1(\xi) = 1$$

$$f_2(t - \xi) = e^{-(t - \xi)}$$

$$f_2(t - \xi) = \begin{cases} 0 & \xi > t \\ e^{-(t - \xi)} & \xi \leq t \end{cases}$$

$$f_1(t) * f_2(t) = \int_{-\infty}^{\infty} 1 \cdot e^{-(t - \xi)} d\xi$$

$$= e^{-t} \int_0^t e^{\xi} d\xi = e^{-t} (e^t - 1) = 1 - e^{-t}$$

$$f_2(t) * f_1(t)$$

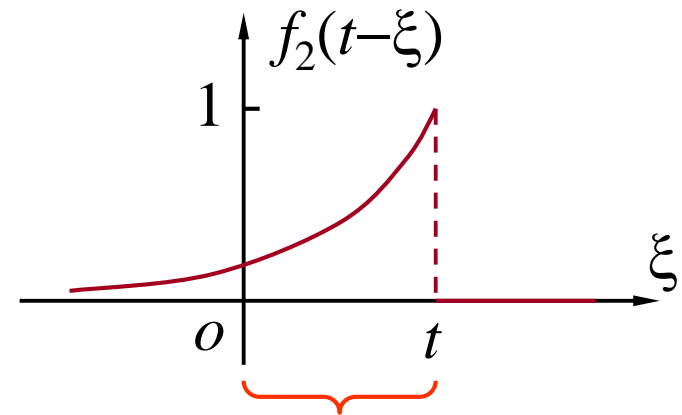
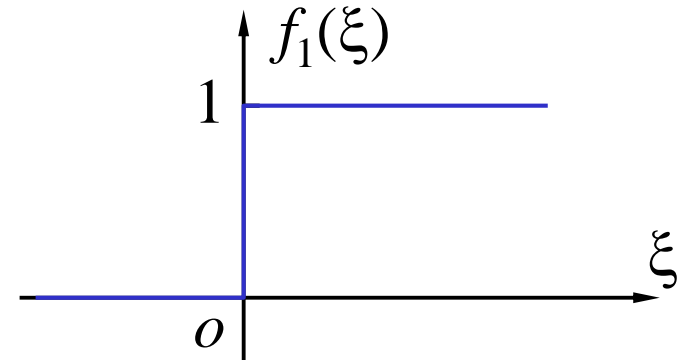

$$f_1(\xi) f_2(t - \xi) = 0$$

$$[0 \quad t]$$





$$f_1(t) \quad f_2(t) \qquad F_1(s) \quad F_2(s)$$

$$f_1(t) * f_2(t)$$

$$\left. \begin{aligned} [f_1(t) * f_2(t)] &= F_1(s) \cdot F_2(s) \\ {}^1 [F_1(s) \cdot F_2(s)] &= f_1(t) * f_2(t) \end{aligned} \right\}$$

-
-

- $R(s) = E(s) H(s)$ $e(t - \xi) h(\xi)$

- $r(t) = {}^1 [E(s) H(s)] = \int_0^t e(\xi) h(t - \xi) d\xi$

$$e(t) \qquad h(t - \xi)$$

14 7

$$i_s(t) = 2e^{-t} \mu\text{A}$$

$$u_C(t)$$

P149 6 2

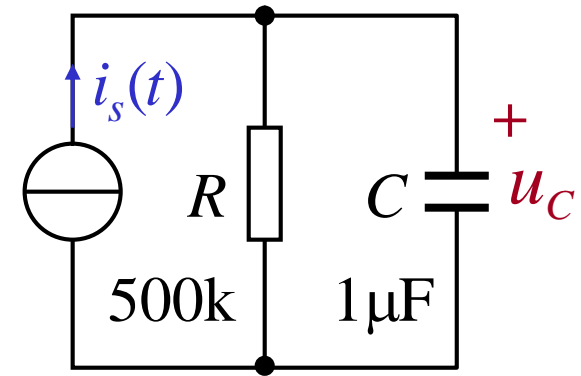

$$h(t) = \frac{1}{C} e^{-\frac{t}{RC}} = \int_0^t 2 \times 10^{-6} e^{-\xi} \times 10^6 e^{-2(t-\xi)} d\xi$$

$$h(t) = 10^6 e^{-2t}$$

$$u_C(t) = \int_0^t [I_S(s)H(s)]$$

$$= 2 \int_0^t e^{-\xi} e^{-2t} e^{2\xi} d\xi$$

$$= 2e^{-2t} \int_0^t e^{\xi} d\xi$$

$$= 2e^{-2t} (e^t - 1)$$

$$u_C(t) = \int_0^t i_s(\xi) h(t-\xi) d\xi$$

$$= 2 (e^{-t} - e^{-2t}) \varepsilon(t) \text{ V}$$



$$F(s) = \frac{s^2}{(s^2 + 1)^2} f(t)$$

$$F(s) = \frac{s}{s^2 + 1} \frac{s}{s^2 + 1}$$

$$f(t) = 1 \left[\frac{s}{s^2 + 1} \frac{s}{s^2 + 1} \right]$$

$$= \cos t * \cos t = \int_0^t \cos \xi \cos(t - \xi) d\xi$$

$$= \frac{1}{2} \int_0^t [\cos t + \cos(2\xi - t)] d\xi$$

$$= \frac{1}{2} (t \cos t + \sin t)$$

