

1.

A

B

Q

2.

3.

§ 15 1

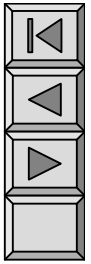

1.

G

G

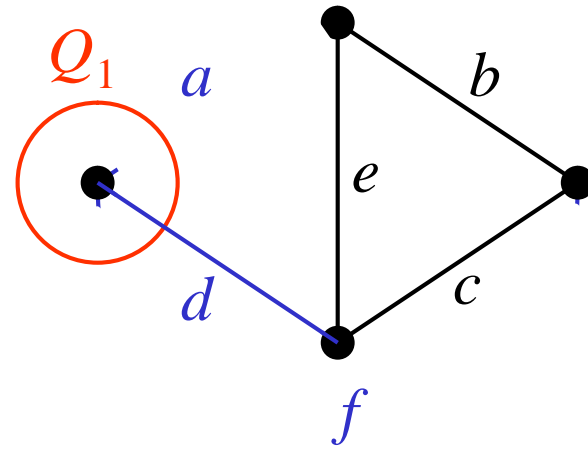

G(

)

G



(a d f)

G

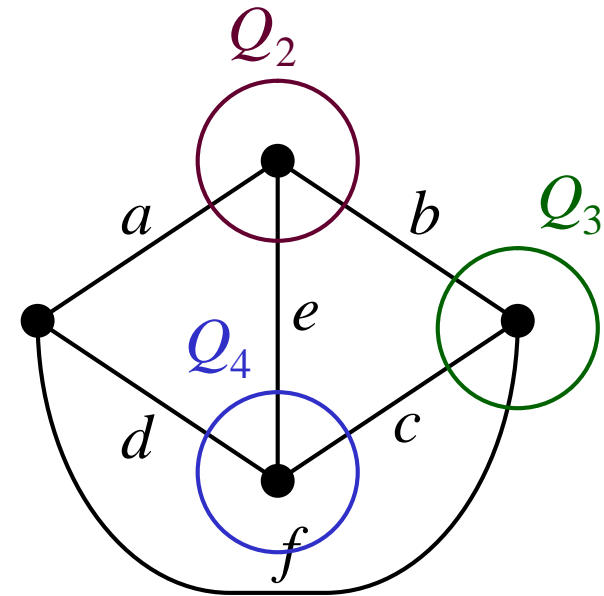

G

(a b e)

(b c f)

(c d e)

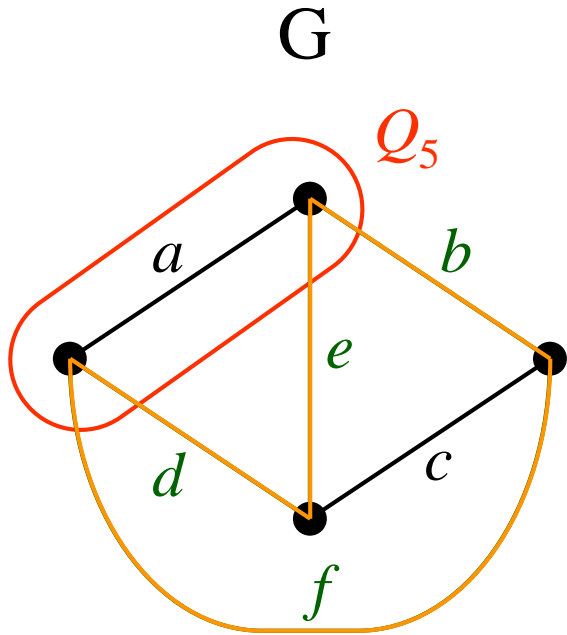
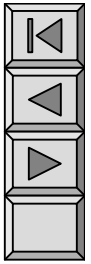

(b, d, e, f)

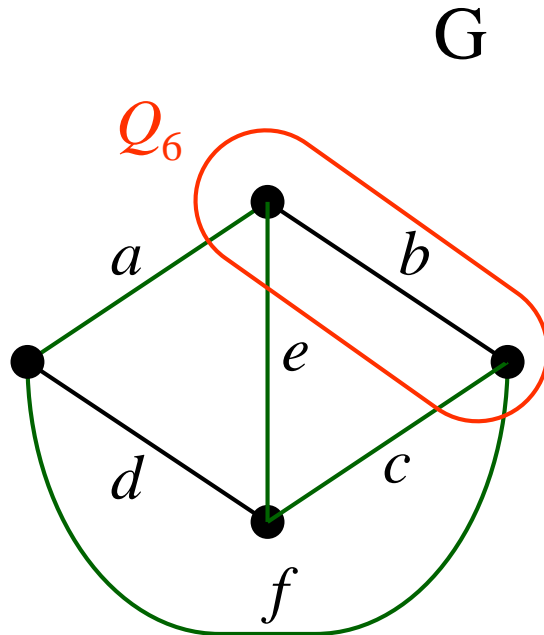

(a, e, c, f)

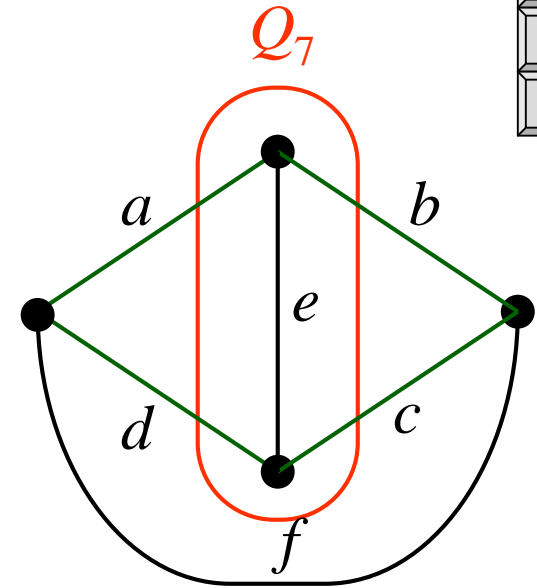

(a, b, c, d)

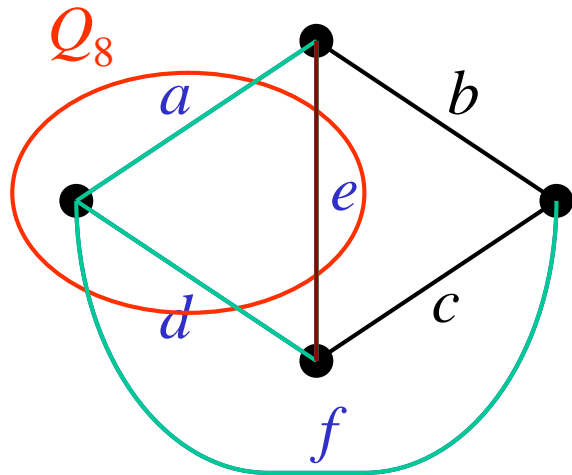

(a, d, e, f)

G
e G

(a, b, c, d, e) G

G

2.

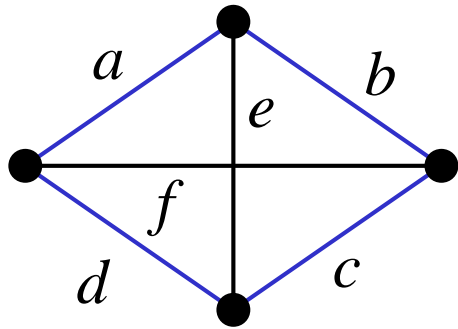
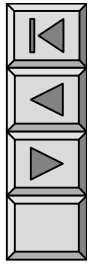
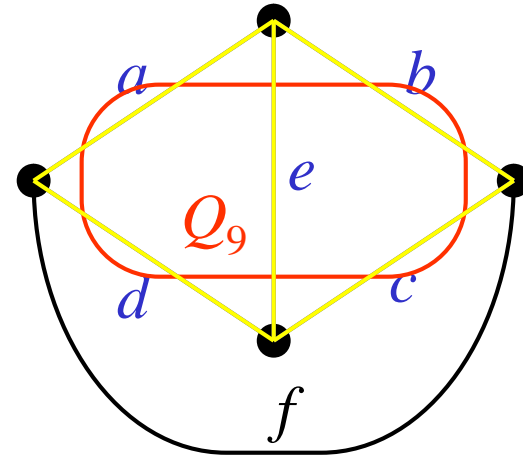

(a, b, c, d)

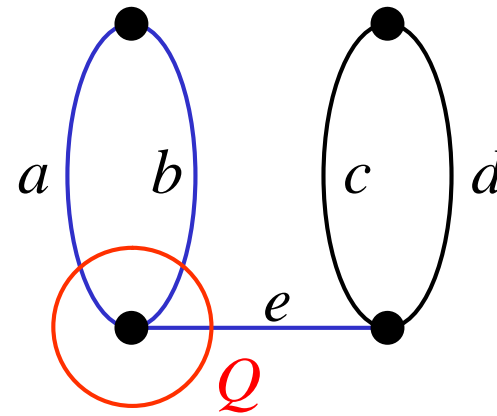

Q
 (a, b, e)

3.

⦿ KCL



KCL



G

KCL

(1)

KCL

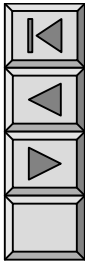
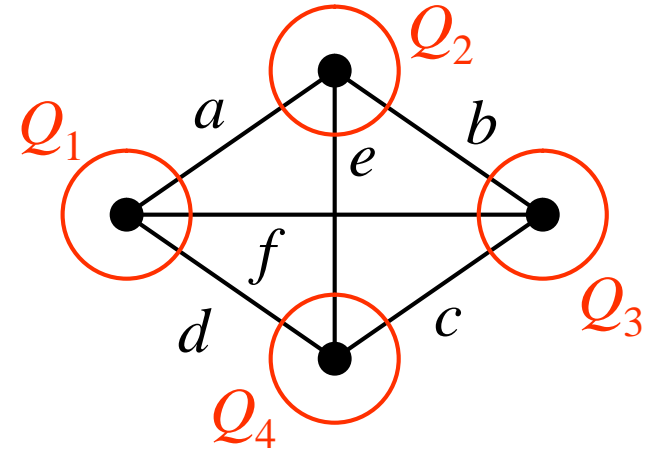

KCL

KCL

(2)

•

•

•

n b

$(n - 1)$

• $(n - 1)$

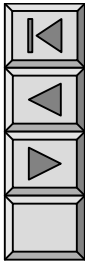
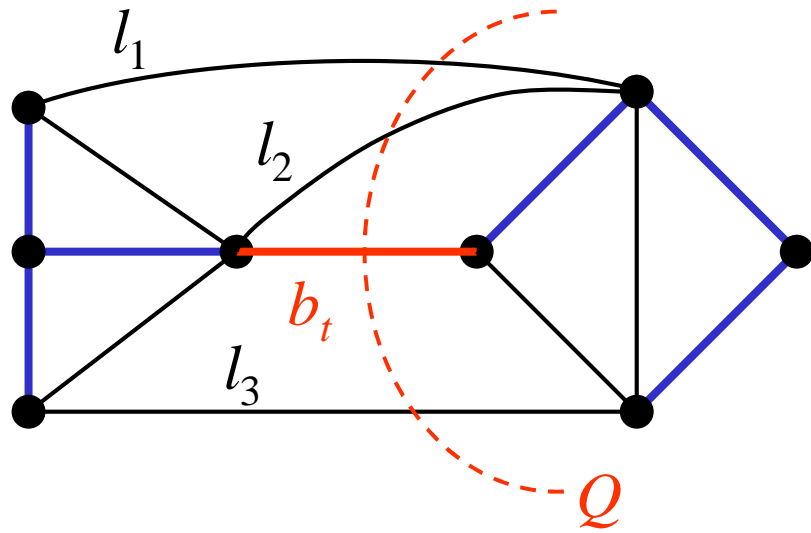

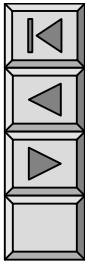

2,3,4,6

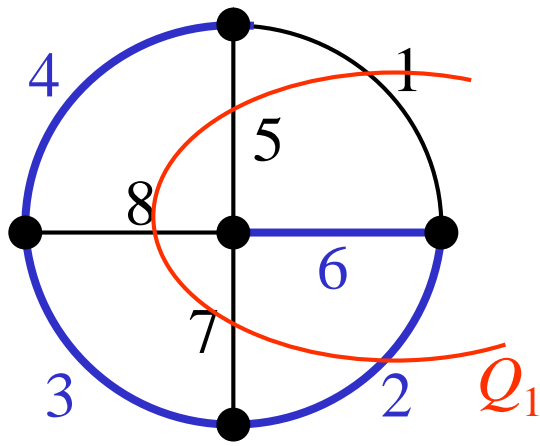

Q_1 (1,2,5,7,8)

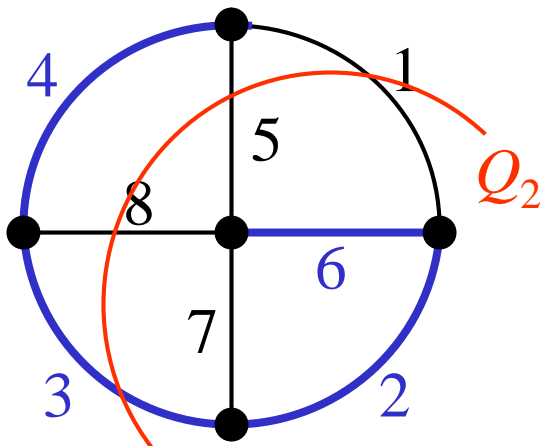

Q_2 (1,3,5,8)

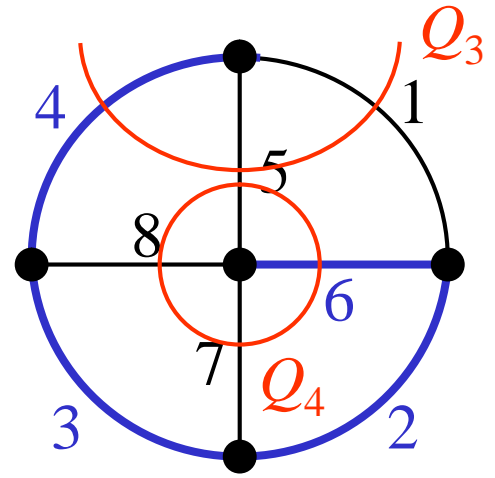

Q_3 (1,4,5)

Q_4 (5,6,7,8)

5,6,7,8

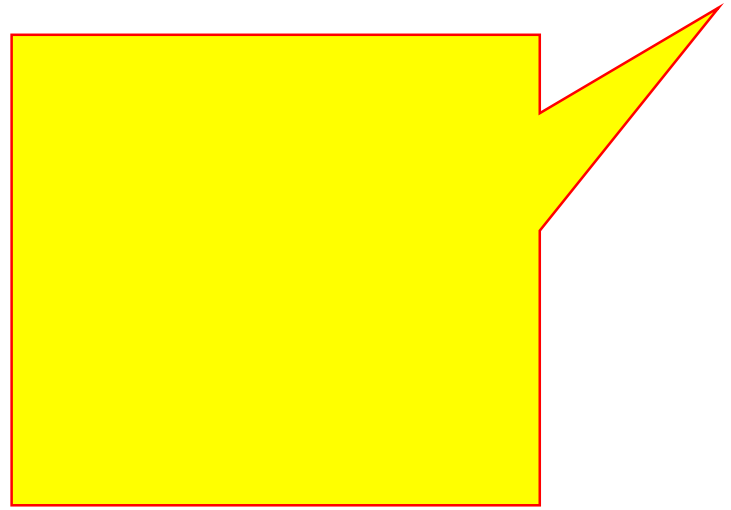
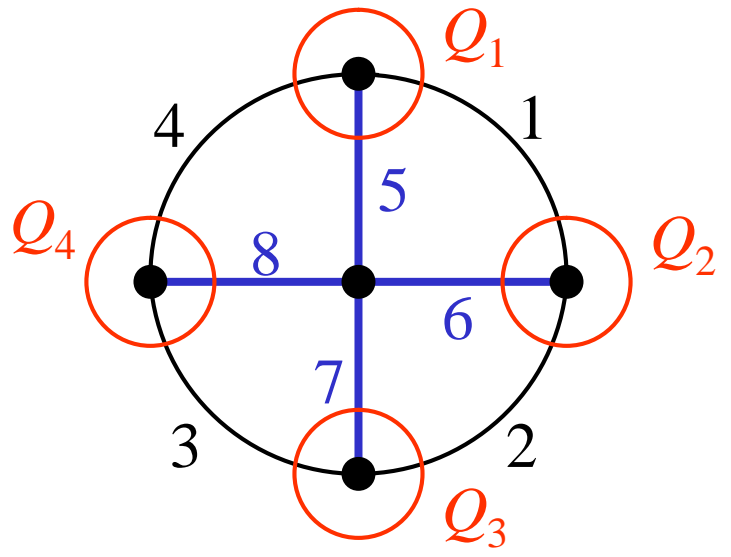

§ 15 2

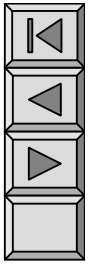

1.

$(n \times b)$

(1) \mathbf{A}_a

$$a_{jk} = +1 \quad k \quad j$$

$$a_{jk} = -1 \quad k \quad j$$

$$a_{jk} = 0 \quad k \quad j$$

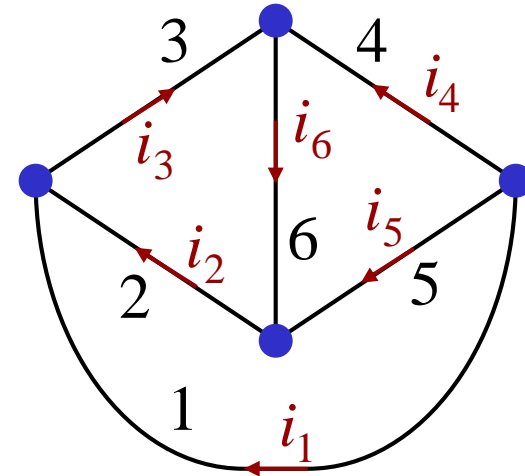

$$\mathbf{A}_a = \begin{matrix} & \begin{matrix} 1 & 2 & 3 & 4 & 5 & 6 \end{matrix} \\ \begin{matrix} 1 \\ 2 \\ 3 \\ 4 \end{matrix} & \begin{bmatrix} 1 & 1 & +1 & 0 & 0 & 0 \\ 0 & 0 & 1 & 1 & 0 & +1 \\ +1 & 0 & 0 & +1 & +1 & 0 \\ 0 & +1 & 0 & 0 & 1 & 1 \end{bmatrix} \end{matrix}$$

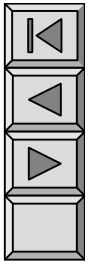

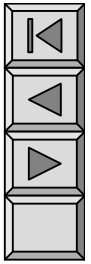

$$A = \begin{bmatrix} 1 & 1 & 1 & 0 & 0 & 0 \\ 0 & 0 & 1 & 1 & 0 & 1 \\ 1 & 0 & 0 & 1 & 1 & 0 \end{bmatrix}$$

(3) A KCL

$b(=6)$

$$i = [i_1, i_2, \dots, i_6]^T$$

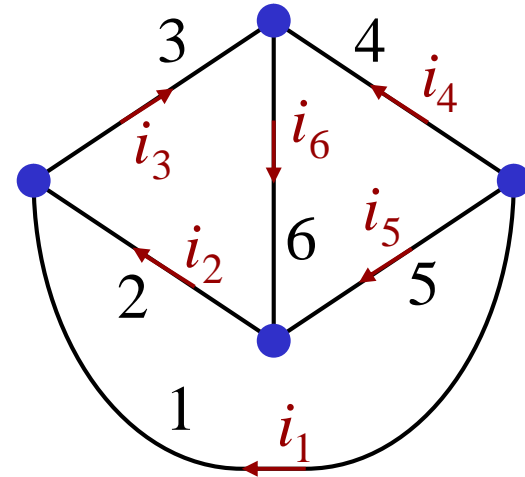

$$Ai = \begin{bmatrix} 1 & 1 & 1 & 0 & 0 & 0 \\ 0 & 0 & 1 & 1 & 0 & 1 \\ 1 & 0 & 0 & 1 & 1 & 0 \end{bmatrix} \begin{bmatrix} i_1 \\ i_2 \\ \cdot \\ \cdot \\ i_6 \end{bmatrix} = \begin{bmatrix} -i_1 & -i_2 & +i_3 \\ -i_3 & -i_4 & +i_6 \\ +i_1 & +i_4 & +i_5 \end{bmatrix} = \begin{bmatrix} 0 \\ 0 \\ 0 \end{bmatrix}$$

$$Ai = \begin{bmatrix} 1 & \text{KCL} \\ 2 & \text{KCL} \\ \dots & \dots \\ (n-1) & \text{KCL} \end{bmatrix} \longrightarrow Ai = \mathbf{0}$$

(4) A KVL

$$b(=6)$$

$$\mathbf{u} = [u_1, u_2, \dots, u_6]^T \quad (\quad)$$

$$(n-1=3)$$

$$\mathbf{u}_n = [u_{n1}, u_{n2}, u_{n3}]^T$$

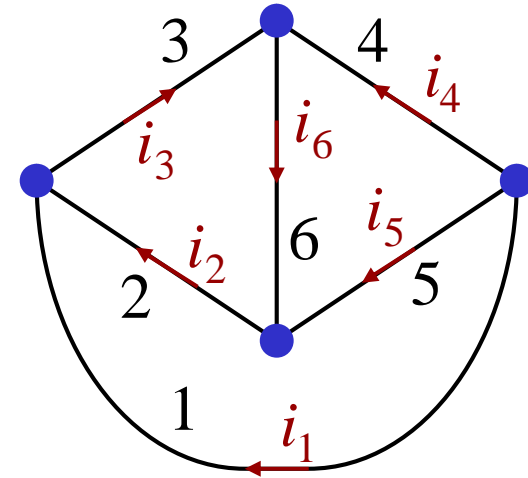

$$\mathbf{u} = \mathbf{A}^T \mathbf{u}_n$$

$$\begin{bmatrix} u_1 \\ u_2 \\ u_3 \\ u_4 \\ u_5 \\ u_6 \end{bmatrix} = \begin{bmatrix} u_{n1} + u_{n3} \\ u_{n1} \\ u_{n1} \quad u_{n2} \\ u_{n2} + u_{n3} \\ u_{n3} \\ u_{n2} \end{bmatrix} = \underbrace{\begin{bmatrix} 1 & 0 & 1 \\ 1 & 0 & 0 \\ 1 & 1 & 0 \\ 0 & 1 & 1 \\ 0 & 0 & 1 \\ 0 & 1 & 0 \end{bmatrix}}_{\mathbf{A}^T} \begin{bmatrix} u_{n1} \\ u_{n2} \\ u_{n3} \end{bmatrix}$$

A
KVL

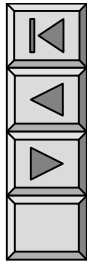

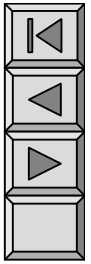

A

A

KCL

$$Ai = 0$$

A

KVL

$$u = A^T u_n$$

2.

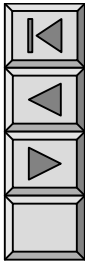

$(l \times b)$

(1)**B**

$$b_{jk} = +1 \quad k \quad j$$

$$b_{jk} = 1 \quad k \quad j$$

$$b_{jk} = 0 \quad k \quad j$$

$$B = \begin{matrix} & \begin{matrix} 1 & 2 & 3 & 4 & 5 & 6 \end{matrix} \\ \begin{matrix} 1 \\ 2 \\ 3 \end{matrix} & \begin{bmatrix} 1 & 0 & 1 & 0 & 1 & 1 \\ 0 & 1 & 1 & 0 & 0 & 1 \\ 0 & 0 & 0 & 1 & 1 & 1 \end{bmatrix} \end{matrix}$$

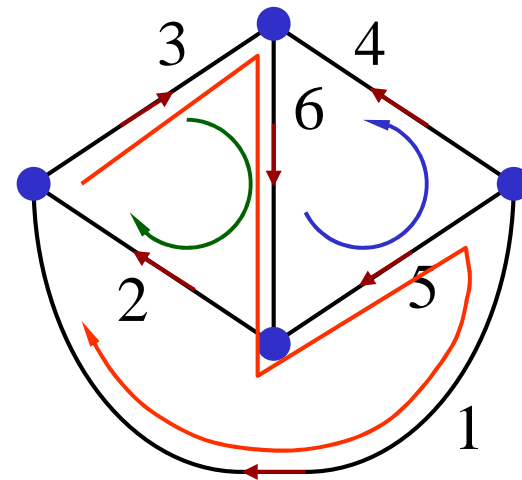

(2)

B_f

B_f



B_f

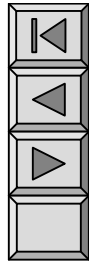
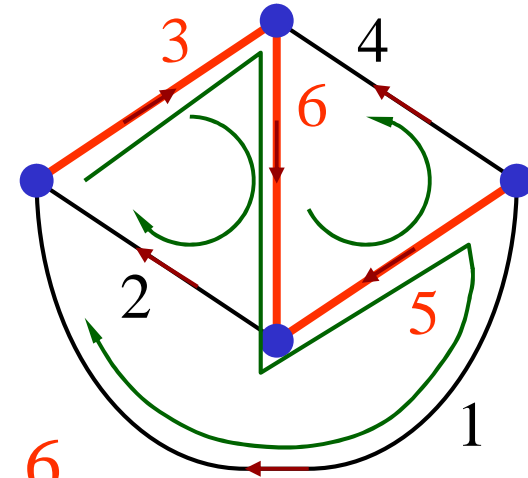

$$B_f = [\mathbf{1}_l \quad B_t]$$

$$B_f = \begin{matrix} 1 \\ 2 \\ 3 \end{matrix} \begin{matrix} 1 & 2 & 4 & 3 & 5 & 6 \\ \left[\begin{array}{c|c|c|c|c|c} 1 & 0 & 0 & 1 & 1 & 1 \\ 0 & 1 & 0 & 1 & 0 & 1 \\ 0 & 0 & 1 & 0 & 1 & 1 \end{array} \right] \end{matrix}$$

$$Bu = 0$$

(3)

B

KVL

$$u_1 + u_3 - u_5 + u_6 = 0$$

$$u_2 + u_3 + u_6 = 0$$

$$u_4 - u_5 + u_6 = 0$$

$$\begin{bmatrix} 1 & 0 & 1 & 0 & -1 & 1 \\ 0 & 1 & 1 & 0 & 0 & 1 \\ 0 & 0 & 0 & 1 & -1 & 1 \end{bmatrix} \begin{bmatrix} u_1 \\ u_2 \\ u_3 \\ u_4 \\ u_5 \\ u_6 \end{bmatrix} = \begin{bmatrix} 0 \\ 0 \\ 0 \end{bmatrix}$$

(4) ***B*** KCL

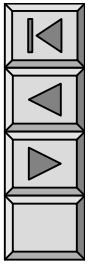

3.

Q

Q $(n-1) \times b$

$$q_{jk} = +1 \quad k \quad j$$

$$q_{jk} = -1 \quad k \quad j$$

$$q_{jk} = 0 \quad k \quad j$$

$$Q = \begin{matrix} & \begin{matrix} 1 & 2 & 3 & 4 & 5 & 6 \end{matrix} \\ \begin{matrix} 1 \\ 2 \\ 3 \end{matrix} & \begin{bmatrix} 1 & 1 & 1 & 0 & 0 & 0 \\ 1 & 0 & 0 & 1 & 1 & 0 \\ 1 & 1 & 0 & 1 & 0 & 1 \end{bmatrix} \end{matrix}$$

Q_f

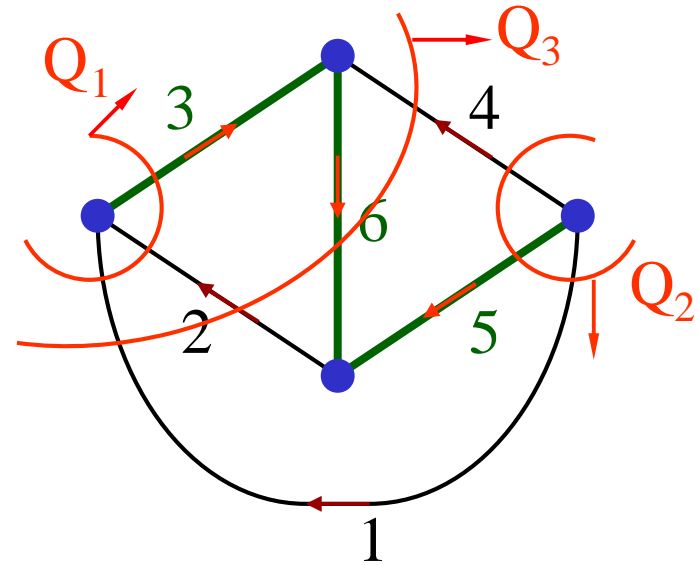

$$Q_f = [\mathbf{1}_t \quad Q_l]$$

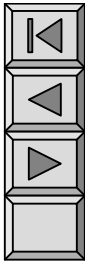

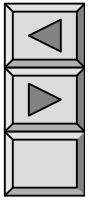

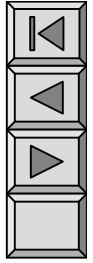

(2) Q_f KVL

$$u = Q_f^T u_t$$

- $u_t = [u_{t1} \ u_{t2} \ \dots \ u_{t(n-1)}]^T$

- $u_t = [u_{t1} \ u_{t2} \ u_{t3}]^T$

$$u = [u_3 \ u_5 \ u_6 \ u_1 \ u_2 \ u_4]^T$$

$$u = \begin{bmatrix} 1 & 0 & 0 \\ 0 & 1 & 0 \\ 0 & 0 & 1 \\ 1 & 1 & 1 \\ 1 & 0 & 1 \\ 0 & 1 & 1 \end{bmatrix} \begin{bmatrix} u_{t1} \\ u_{t2} \\ u_{t3} \end{bmatrix} = \begin{bmatrix} u_{t1} \\ u_{t2} \\ u_{t3} \\ -u_{t1} + u_{t2} - u_{t3} \\ -u_{t1} - u_{t3} \\ u_{t2} - u_{t3} \end{bmatrix} \begin{matrix} = u_3 \\ = u_5 \\ = u_6 \\ = u_1 \\ = u_2 \\ = u_4 \end{matrix}$$

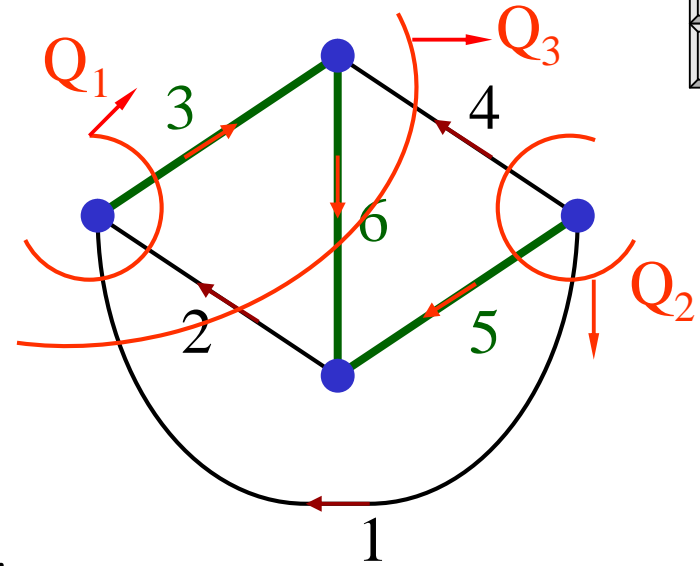

bf i"yo †—e5

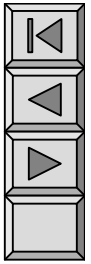

*§ 15 3 A B_f Q_f

1. $A i = 0$ $Q i = 0$
 $u = A^T u_n$ $u = Q_f^T u_t$
 G $Q_f = A$

2. G A B Q

$$AB^T = 0 \quad BA^T = 0$$

$$QB^T = 0 \quad BQ^T = 0$$

3. A B_f Q_f

$$B_t^T = A_t^{-1} A_l \quad Q_l = B_t^T = A_t^{-1} A_l$$

§ 15 4

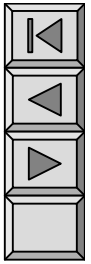

(1) Z_k R L

C

(2)

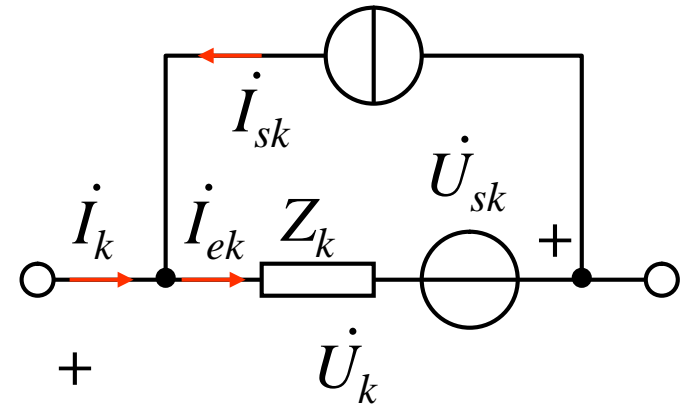

$$\dot{U}_k = Z_k (\dot{I}_k + \dot{I}_{Sk}) \quad \dot{U}_{Sk}$$

$$\dot{\mathbf{I}} = [\dot{I}_1 \quad \dot{I}_2 \quad \cdots \quad \dot{I}_b]^T$$

$$\dot{\mathbf{U}} = [\dot{U}_1 \quad \dot{U}_2 \quad \cdots \quad \dot{U}_b]^T$$

$$\dot{\mathbf{I}}_S = [\dot{I}_{S1} \quad \dot{I}_{S2} \quad \cdots \quad \dot{I}_{Sb}]^T$$

$$\dot{\mathbf{U}}_S = [\dot{U}_{S1} \quad \dot{U}_{S2} \quad \cdots \quad \dot{U}_{Sb}]^T$$

$$\dot{\mathbf{U}} = \mathbf{Z} (\dot{\mathbf{I}} + \dot{\mathbf{I}}_S) \quad \dot{\mathbf{U}}_S$$

✓ 1

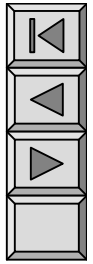

$$\dot{U} = \mathbf{Z} (\dot{\mathbf{i}} + \dot{\mathbf{i}}_S) \quad \dot{U}_S$$

$$\mathbf{Z} \quad \mathbf{Z}$$

$$\mathbf{Z} = \begin{bmatrix} Z_1 & & & \mathbf{0} \\ & Z_2 & & \\ & & \ddots & \\ \mathbf{0} & & & Z_b \end{bmatrix}$$

✓ 2
b

1 g

$$\dot{U}_1 = Z_1 \dot{I}_{e1} \pm j\omega M_{12} \dot{I}_{e2} \pm j\omega M_{13} \dot{I}_{e3} \pm \dots \pm j\omega M_{1g} \dot{I}_{eg} \quad \dot{U}_{S1}$$

$$\dot{U}_2 = \pm j\omega M_{21} \dot{I}_{e1} + Z_2 \dot{I}_{e2} \pm j\omega M_{23} \dot{I}_{e3} \pm \dots \pm j\omega M_{2g} \dot{I}_{eg} \quad \dot{U}_{S2}$$

... ..

$$\dot{U}_g = \pm j\omega M_{g1} \dot{I}_{e1} \pm j\omega M_{g2} \dot{I}_{e2} \pm j\omega M_{g3} \dot{I}_{e3} \pm \dots + Z_g \dot{I}_{eg} \quad \dot{U}_{Sg}$$

$$\dot{I}_{e1} = \dot{I}_1 + \dot{I}_{S1} \quad \dot{I}_{e2} = \dot{I}_2 + \dot{I}_{S2} \quad \dots \dots \quad M_{12} = M_{21} \quad \dots \dots$$

(g+1) b

1

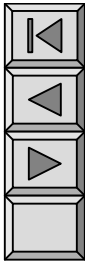

$$\begin{bmatrix} \dot{U}_1 \\ \dot{U}_2 \\ \vdots \\ \dot{U}_g \\ \dot{U}_{g+1} \\ \vdots \\ \dot{U}_b \end{bmatrix} = \begin{bmatrix} Z_1 & \pm j\omega M_{12} & \cdots & \pm j\omega M_{1g} & 0 & \cdots & 0 \\ \pm j\omega M_{21} & Z_2 & \cdots & \pm j\omega M_{2g} & 0 & \cdots & 0 \\ \vdots & \vdots & & \vdots & \vdots & & \vdots \\ \pm j\omega M_{g1} & \pm j\omega M_{g2} & \cdots & Z_g & 0 & \cdots & 0 \\ 0 & 0 & \cdots & 0 & Z_{g+1} & \cdots & 0 \\ \vdots & \vdots & & \vdots & \vdots & & \vdots \\ 0 & 0 & \cdots & 0 & 0 & \cdots & Z_b \end{bmatrix}$$

$$\dot{U} = Z (\dot{I} + \dot{I}_S) \quad \dot{U}_S$$

$$\times \begin{bmatrix} \dot{I}_1 + \dot{I}_{S1} \\ \dot{I}_2 + \dot{I}_{S2} \\ \vdots \\ \dot{I}_g + \dot{I}_{Sg} \\ \dot{I}_{g+1} + \dot{I}_{S(g+1)} \\ \vdots \\ \dot{I}_b + \dot{I}_{Sb} \end{bmatrix} - \begin{bmatrix} \dot{U}_{S1} \\ \dot{U}_{S2} \\ \vdots \\ \dot{U}_{Sg} \\ \dot{U}_{S(g+1)} \\ \vdots \\ \dot{U}_{Sb} \end{bmatrix}$$

Z

✓

3

•

•

•

•

•

Z

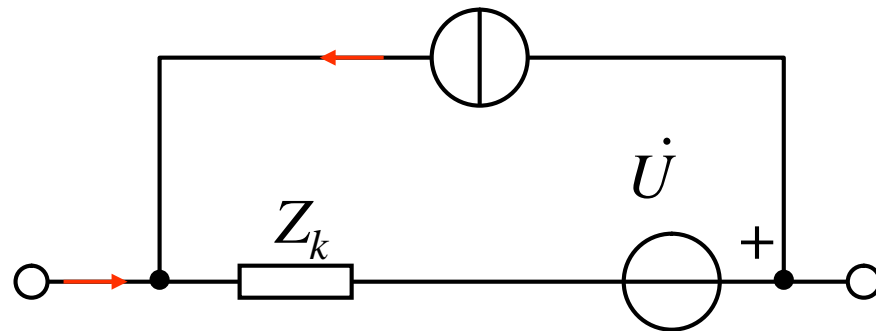

() “+” “ ”

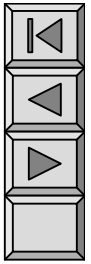

$$\begin{aligned} B \quad \text{KVL} \quad B\dot{U} &= \mathbf{0} \\ \dot{U} &= Z(\dot{I} + \dot{I}_S) \quad \dot{U}_S \\ BZ\dot{I} + BZ\dot{I}_S - B\dot{U}_S &= \mathbf{0} \\ B \quad \text{KCL} \quad \dot{I} &= B^T \dot{I}_l \end{aligned}$$

$$\begin{aligned} BZB^T \dot{I} &= B\dot{U}_S - BZ\dot{I}_S \\ BZB^T \quad l \quad B\dot{U}_S \quad BZ \quad l \\ Z_l &= BZB^T \quad Z_l \\ Z_l \end{aligned}$$

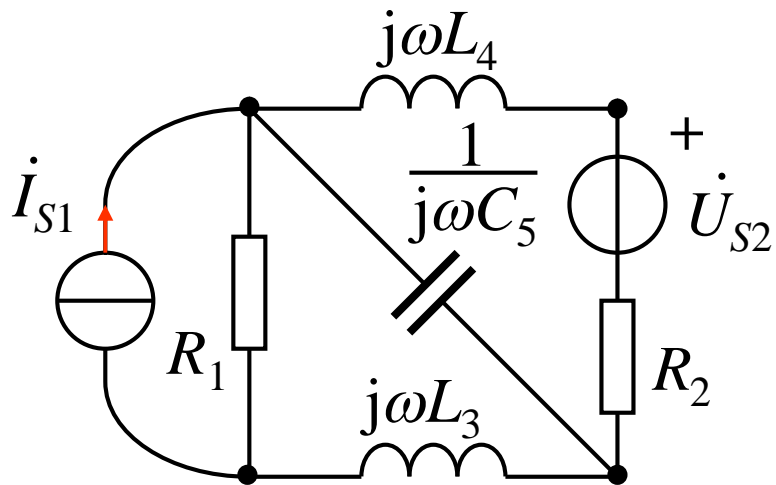
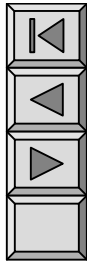

(2)

(3)

B

(1)

$$B = \begin{bmatrix} 1 & 0 & 1 & 0 & 1 \\ 0 & 1 & 0 & 1 & 1 \end{bmatrix}$$

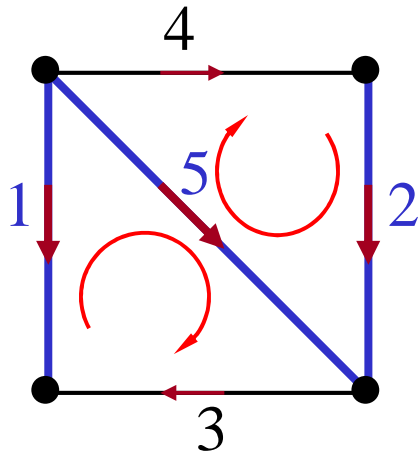

$$Z = \text{diag} [R_1, R_2, j\omega L_3, j\omega L_4, \frac{1}{j\omega C_5}]$$

$$\dot{U}_S = [0 \quad -\dot{U}_{S2} \quad 0 \quad 0 \quad 0]^T$$

$$\dot{I}_S = [\dot{I}_{S1} \quad 0 \quad 0 \quad 0 \quad 0]^T$$

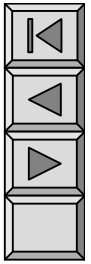

(4) $Z_l = BZB^T$

$$Z_l = BZB^T = \begin{bmatrix} 1 & 0 & 1 & 0 & 1 \\ 0 & 1 & 0 & 1 & 1 \end{bmatrix} \begin{bmatrix} R_1 & & & & \\ & R_2 & & & \\ & & j\omega L_3 & & \\ & & & j\omega L_4 & \\ & & & & \frac{1}{j\omega C_5} \end{bmatrix} \begin{bmatrix} 1 & 0 \\ 0 & 1 \\ 1 & 0 \\ 0 & 1 \\ 1 & 1 \end{bmatrix}$$

$$\begin{bmatrix} R_1 + j\omega L_3 + \frac{1}{j\omega C_5} & -\frac{1}{j\omega C_5} \\ -\frac{1}{j\omega C_5} & R_2 + j\omega L_4 + \frac{1}{j\omega C_5} \end{bmatrix} \begin{bmatrix} \dot{I}_{l1} \\ \dot{I}_{l2} \end{bmatrix} = \begin{bmatrix} R_1 \dot{I}_{S1} \\ \dot{U}_{S2} \end{bmatrix}$$

(5) $Z_l \dot{U}_S \dot{I}_S \quad Z_l \dot{I} = B \dot{U}_S \quad BZ \dot{I}_S$

§ 15 5

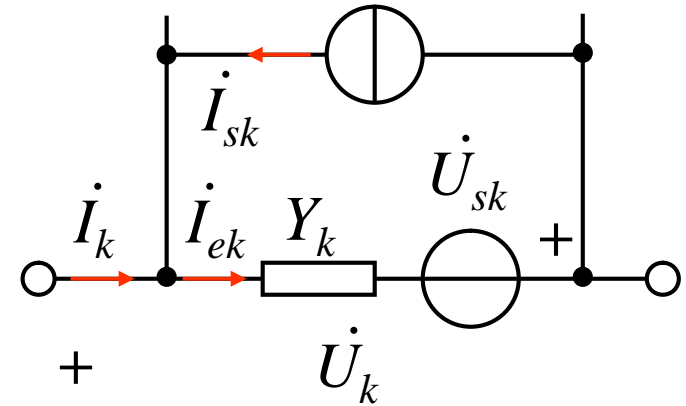
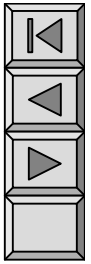

1

k

$$i_k = Y_k (\dot{U}_k + \dot{U}_{Sk}) - i_{Sk}$$

$$i = Y (\dot{U} + \dot{U}_S) - i_S$$

Y

Y

✓ 2

$$\dot{U} = Z (\dot{I} + \dot{I}_S) \quad \dot{U}_S$$

2

Z

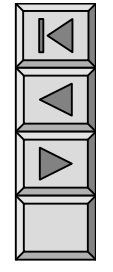
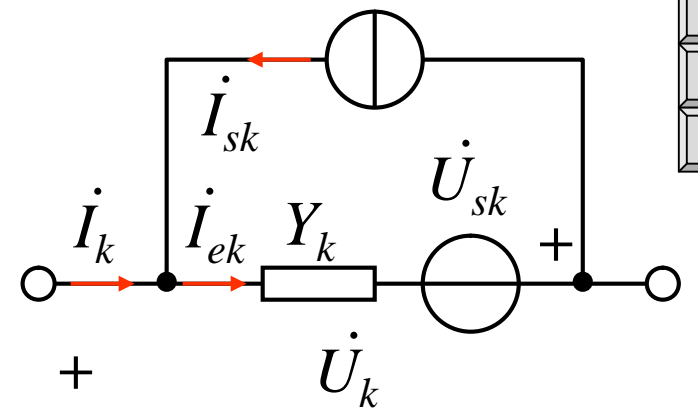

Z

$$Y \dot{U} = \dot{I} + \dot{I}_S \quad Y \dot{U}_S$$

$$\dot{I} = Y (\dot{U} \quad \dot{U}_S) \quad \dot{I}_S$$

$$Y = Z^{-1}$$

VCR

1

Y



3

$$\begin{matrix}
 & k & & j \\
 & & (&) \\
 \underline{\dot{I}_{dk}} = g_{kj} \dot{U}_{ej} & & \dot{I}_{dk} = \beta_{kj} \dot{I}_{ej} \\
 \dot{I}_{ej} = Y_j \dot{U}_{ej} & & \underline{\dot{I}_{dk}} = \beta_{kj} Y_j \dot{U}_{ej}
 \end{matrix}$$

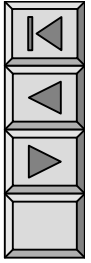
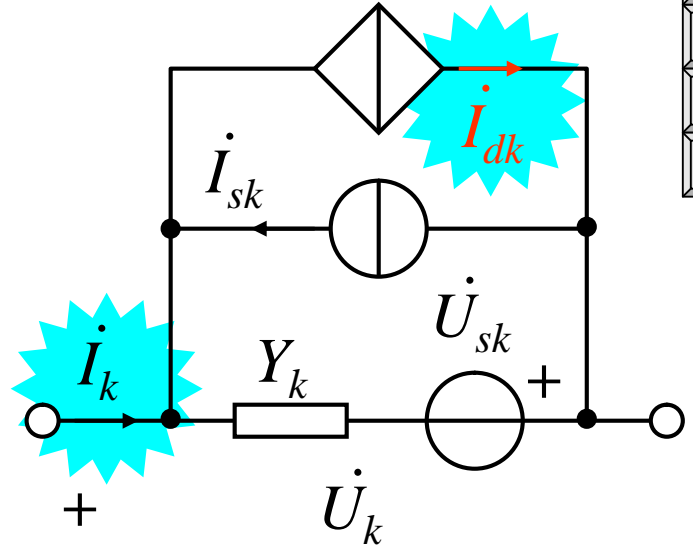

VCCS

Y_{kj}

$$Y_{kj} = \begin{cases} g_{kj} \\ \beta_{kj} Y_j \end{cases}$$

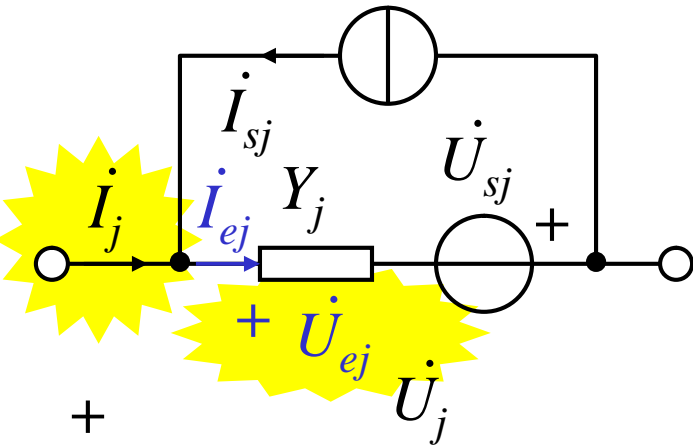

$$\dot{I}_k = Y_k (\dot{U}_k + \dot{U}_{Sk}) + \dot{I}_{dk} \quad \dot{I}_{Sk}$$

$$\dot{I}_{dk} = Y_{kj} \dot{U}_{ej} = Y_{kj} (\dot{U}_j + \dot{U}_{Sj})$$

$$\dot{I}_k = Y_k (\dot{U}_k + \dot{U}_{Sk}) + Y_{kj} (\dot{U}_j + \dot{U}_{Sj}) \quad \dot{I}_{Sk}$$

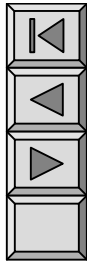

$$\begin{array}{l} \mathbf{A} \quad \text{KCL} \quad \mathbf{A} \dot{\mathbf{I}} = \mathbf{0} \quad \mathbf{A} \quad \text{KVL} \quad \dot{\mathbf{U}} = \mathbf{A}^T \dot{\mathbf{U}}_n \\ \dot{\mathbf{I}} = \mathbf{Y} (\dot{\mathbf{U}} \quad \dot{\mathbf{U}}_S) \quad \dot{\mathbf{I}}_S \end{array}$$

$$\dot{\mathbf{I}} = \mathbf{Y} \mathbf{A}^T \dot{\mathbf{U}}_n \quad \mathbf{Y} \dot{\mathbf{U}}_S \quad \dot{\mathbf{I}}_S$$

$$\begin{array}{l} \mathbf{A} \quad \text{KCL} \quad \mathbf{A} \mathbf{Y} \mathbf{A}^T \dot{\mathbf{U}}_n \quad \mathbf{A} \mathbf{Y} \dot{\mathbf{U}}_S \quad \mathbf{A} \dot{\mathbf{I}}_S = \mathbf{0} \\ \mathbf{A} \mathbf{Y} \mathbf{A}^T \dot{\mathbf{U}}_n = \mathbf{A} \dot{\mathbf{I}}_S \quad \mathbf{A} \mathbf{Y} \dot{\mathbf{U}}_S \end{array}$$

$$\begin{array}{l} \mathbf{Y}_n = \mathbf{A} \mathbf{Y} \mathbf{A}^T, \quad \mathbf{J}_n = \mathbf{A} \dot{\mathbf{I}}_S \quad \mathbf{A} \mathbf{Y} \dot{\mathbf{U}}_S \\ \mathbf{Y}_n \dot{\mathbf{U}}_n = \mathbf{J}_n \end{array}$$

\mathbf{Y}_n
 \mathbf{J}_n

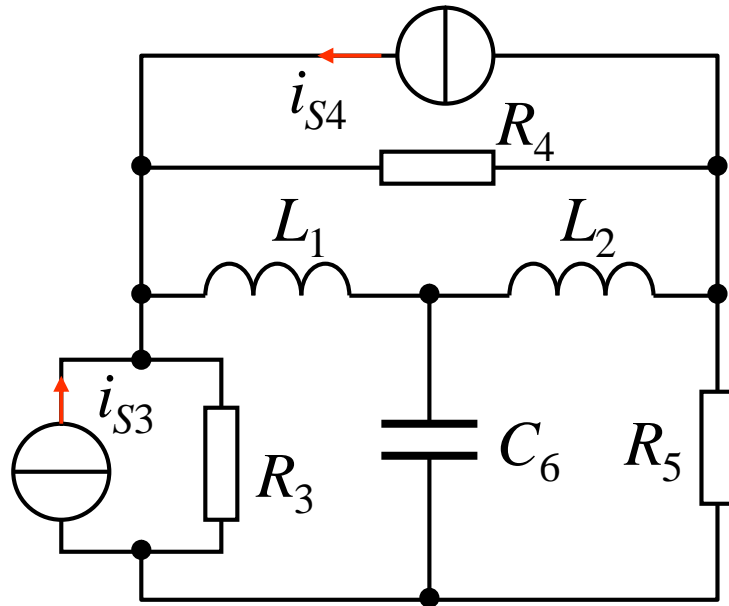
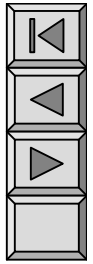

(1)

(2)

A

$$A = \begin{bmatrix} 1 & 0 & 1 & 1 & 0 & 0 \\ 1 & 1 & 0 & 0 & 0 & 1 \\ 0 & 1 & 0 & 1 & 1 & 0 \end{bmatrix}$$

$$\dot{U}_s = \mathbf{0}, \quad \dot{I}_s = [0 \ 0 \ I_{S3} \ I_{S4} \ 0 \ 0]^T$$

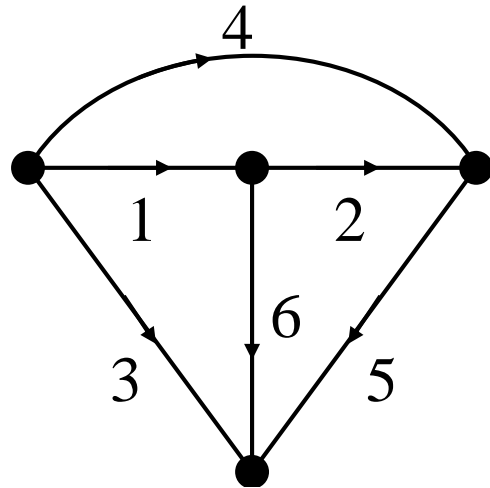

$$Y = \text{diag} \left[\frac{1}{j\omega L_1}, \frac{1}{j\omega L_2}, \frac{1}{R_3}, \frac{1}{R_4}, \frac{1}{R_5}, j\omega C_6 \right]$$

(3) AYA^T

$$AYA^T \dot{U}_n = A \dot{I}_s \quad A \dot{U}_s$$

$$AYA^T \dot{U}_n = A \dot{I}_s$$

$$\begin{bmatrix} \frac{1}{R_3} + \frac{1}{R_4} + \frac{1}{j\omega L_1} & -\frac{1}{j\omega L_1} & -\frac{1}{R_4} \\ -\frac{1}{j\omega L_1} & \frac{1}{j\omega L_1} + \frac{1}{j\omega L_2} + j\omega C_6 & -\frac{1}{j\omega L_2} \\ -\frac{1}{R_4} & -\frac{1}{j\omega L_2} & \frac{1}{R_4} + \frac{1}{R_5} + \frac{1}{j\omega L_2} \end{bmatrix} \begin{bmatrix} \dot{U}_{n1} \\ \dot{U}_{n2} \\ \dot{U}_{n3} \end{bmatrix} = \begin{bmatrix} \dot{I}_{S3} + \dot{I}_{S4} \\ 0 \\ -\dot{I}_{S4} \end{bmatrix}$$

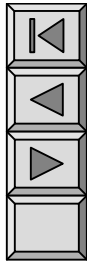

AYA^T

\dot{U}_n

$A\dot{I}_S$

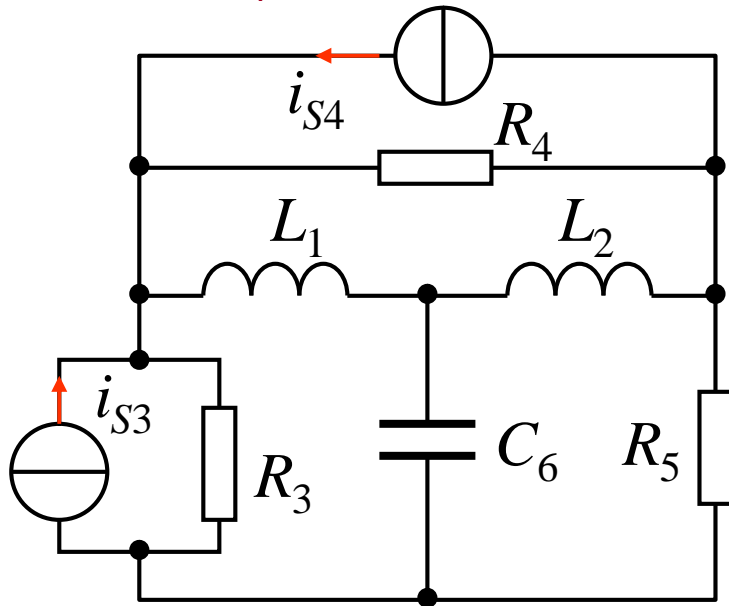

()

P406 15 3

$$\dot{I}_{d2} = g_{21} \dot{U}_1, \dot{I}_{d4} = \beta_{46} \dot{I}_6$$

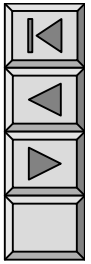

$$\mathbf{Y} = \begin{bmatrix}
 \frac{1}{R_1} & 0 & 0 & 0 \\
 -g_{21} & \frac{1}{R_2} & 0 & 0 \\
 j\omega C_3 & j\omega C_4 & 0 & 0 \\
 0 & 0 & \frac{\beta_{46}}{j\omega L_6} & 0 \\
 0 & 0 & 0 & \frac{1}{j\omega L_6}
 \end{bmatrix}$$

(1 2 3 4 5 6)

A red checkmark is placed below the matrix. A blue arrow points from the matrix towards the circuit diagram.

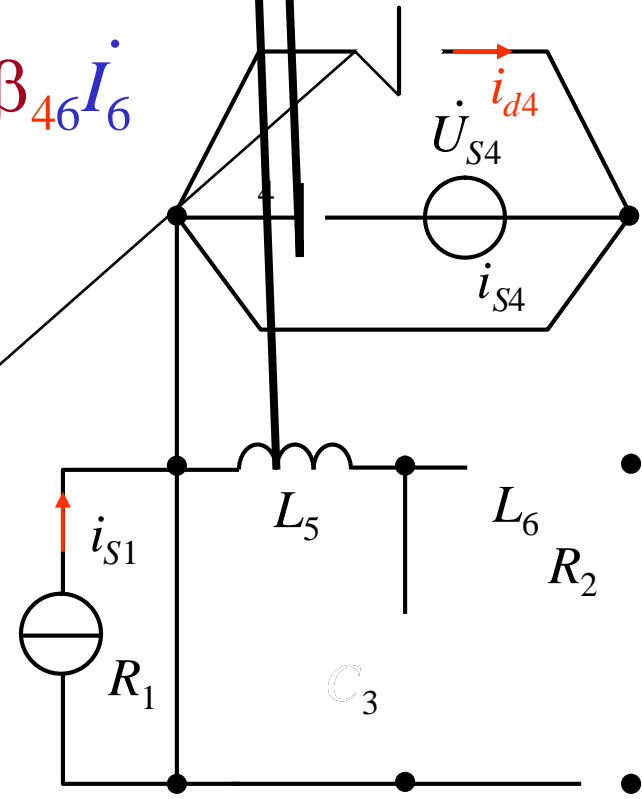

$$\dot{\mathbf{I}}_S = [\dot{I}_{S1} \quad 0 \quad 0 \quad -\dot{I}_{S4} \quad 0 \quad 0]^T$$

$$\dot{\mathbf{U}}_S = [0 \quad -\dot{U}_{S2} \quad 0 \quad \dot{U}_{S4} \quad 0 \quad 0]^T$$

$$\dot{\mathbf{I}} = \mathbf{Y} (\dot{\mathbf{U}} \quad \dot{\mathbf{U}}_S) \quad \dot{\mathbf{I}}_S$$

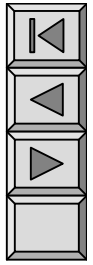
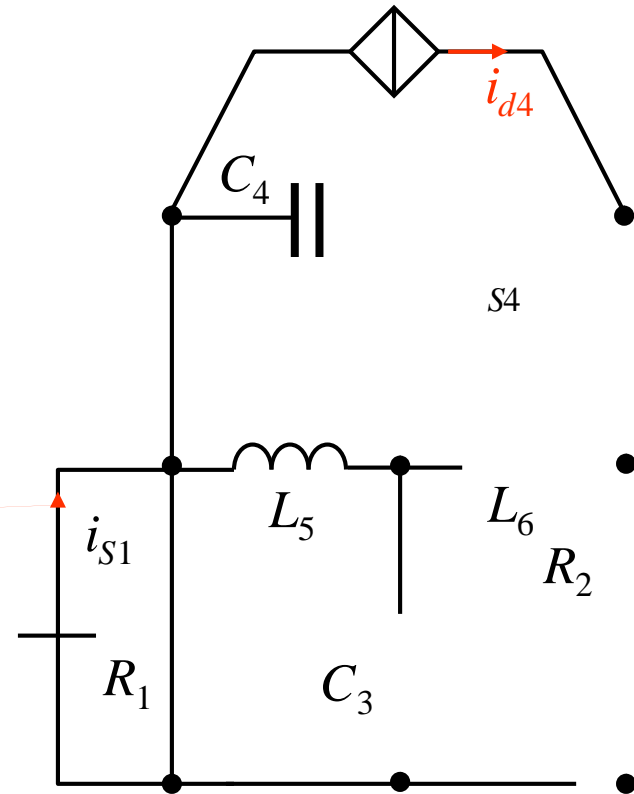

§ 15 6

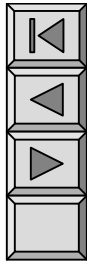
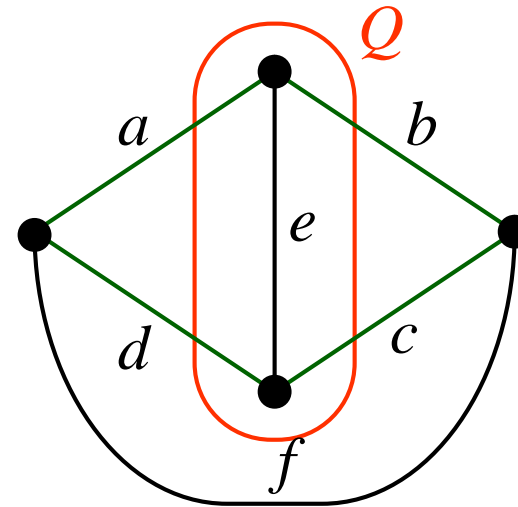

()

$$\mathbf{u} = \mathbf{Q}_f^T \mathbf{u}_t$$
$$\mathbf{u}_t$$

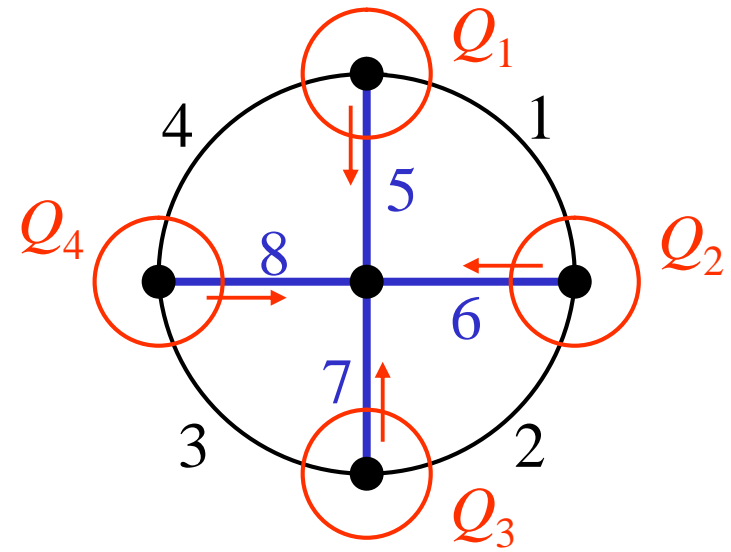
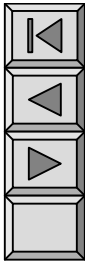

$$\dot{I} = Y (\dot{U} \quad \dot{U}_S) \quad \dot{I}_S$$

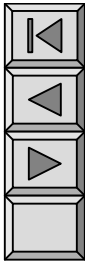

$$\begin{array}{l} \mathbf{Q}_f \quad \text{KCL} \quad \mathbf{Q}_f \dot{\mathbf{I}} = \mathbf{0} \quad \mathbf{Q}_f \quad \text{KVL} \quad \dot{\mathbf{U}} = \mathbf{Q}_f^T \dot{\mathbf{U}}_t \\ \dot{\mathbf{I}} = \mathbf{Y} (\dot{\mathbf{U}} \quad \dot{\mathbf{U}}_s) \quad \dot{\mathbf{I}}_s \\ \dot{\mathbf{I}} = \mathbf{Y} \mathbf{Q}_f^T \dot{\mathbf{U}}_t \quad \mathbf{Y} \dot{\mathbf{U}}_s \quad \dot{\mathbf{I}}_s \end{array}$$

$$\mathbf{Q}_f \quad \text{KCL}$$

$$\mathbf{Q}_f \mathbf{Y} \mathbf{Q}_f^T \dot{\mathbf{U}}_t = \mathbf{Q}_f \dot{\mathbf{I}}_s \quad \mathbf{Q}_f \mathbf{Y} \dot{\mathbf{U}}_s$$

$$\mathbf{Y}_t = \mathbf{Q}_f \mathbf{Y} \mathbf{Q}_f^T \quad \mathbf{Y}_t$$

P408 15 4

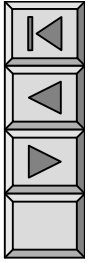

1 2 3

$U_{t1}(s)$ $U_{t2}(s)$ $U_{t3}(s)$

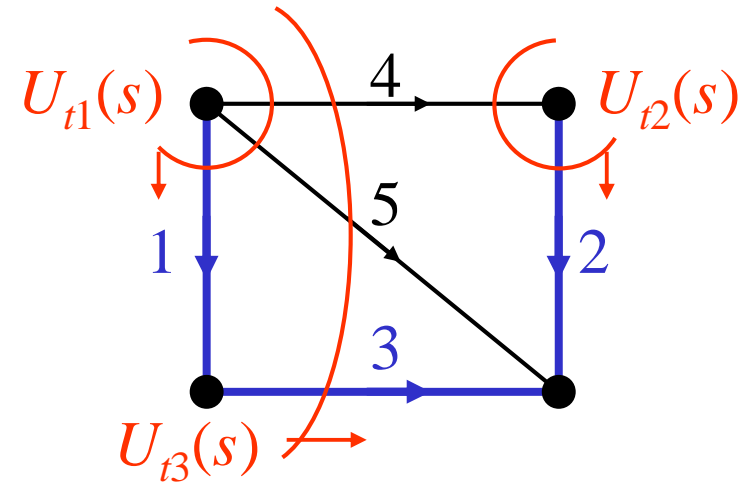
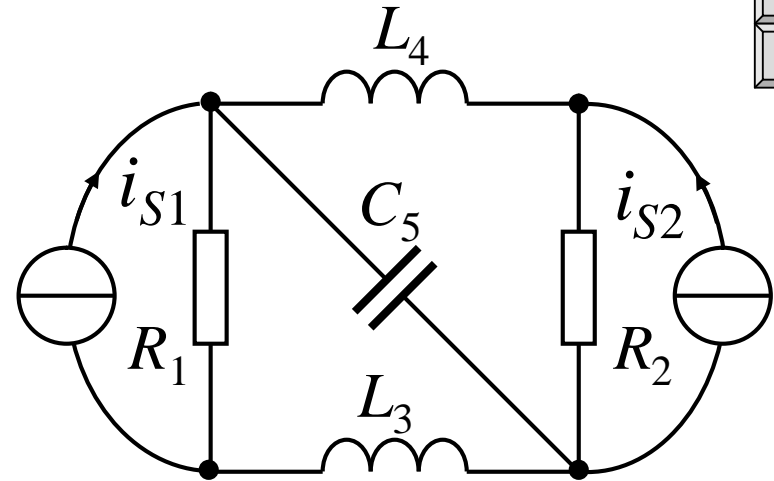

$$Q_f = \begin{bmatrix} 1 & 0 & 0 & 1 & 1 \\ 0 & 1 & 0 & 1 & 0 \\ 0 & 0 & 1 & 1 & 1 \end{bmatrix} \begin{matrix} Q_1 \\ Q_2 \\ Q_3 \end{matrix}$$

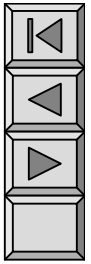

$$U_S(s) = 0$$

$$I_S(s) = [I_{S1}(s) \ I_{S2}(s) \ 0 \ 0 \ 0]^T$$

$$Y(s) = \text{diag} \left[\frac{1}{R_1}, \frac{1}{R_2}, \frac{1}{sL_3}, \frac{1}{sL_4}, sC_5 \right]$$

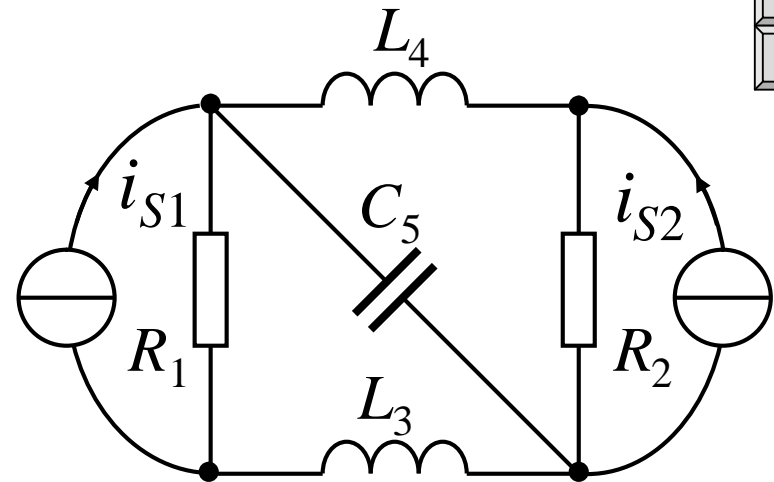

$$Q_f Y(s) Q_f^T U_t(s) = Q_f I_S(s) - Q_f Y(s) U_S(s)$$

$$\begin{bmatrix} \frac{1}{R_1} + \frac{1}{sL_4} + sC_5 & -\frac{1}{sL_4} & \frac{1}{sL_4} + sC_5 \\ -\frac{1}{sL_4} & \frac{1}{R_2} + \frac{1}{sL_4} & -\frac{1}{sL_4} \\ \frac{1}{sL_4} + sC_5 & -\frac{1}{sL_4} & \frac{1}{sL_3} + \frac{1}{sL_4} + sC_5 \end{bmatrix} \begin{bmatrix} U_{t1}(s) \\ U_{t2}(s) \\ U_{t3}(s) \end{bmatrix} = \begin{bmatrix} I_{S1}(s) \\ I_{S2}(s) \\ 0 \end{bmatrix}$$

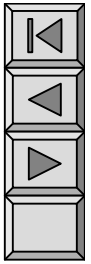
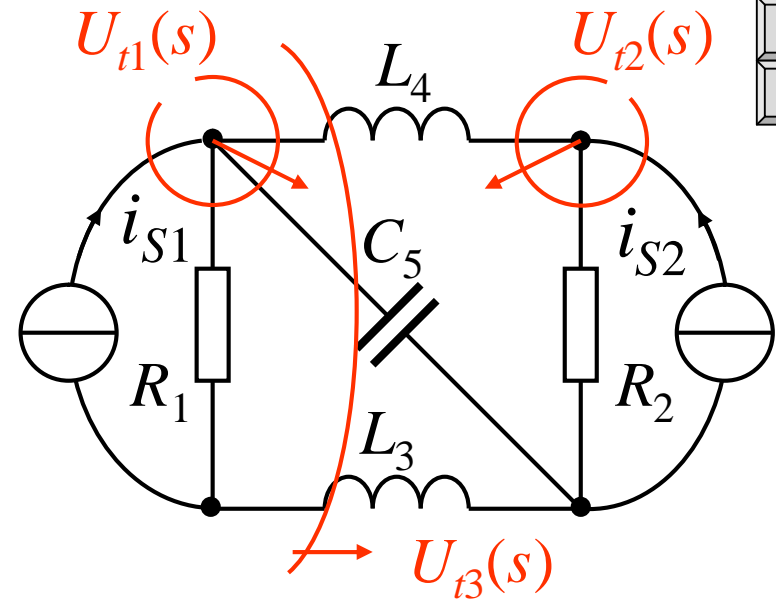
Y_t $Q_1 \quad Q_2 \quad Q_3$ 

“ ”

“ + ”

“ ”

$$\begin{bmatrix}
 \frac{1}{R_1} + \frac{1}{sL_4} + sC_5 & -\frac{1}{sL_4} & \frac{1}{sL_4} + sC_5 \\
 -\frac{1}{sL_4} & \frac{1}{R_2} + \frac{1}{sL_4} & -\frac{1}{sL_4} \\
 \frac{1}{sL_3} + \frac{1}{sL_4} + sC_5 & -\frac{1}{sL_4} & \frac{1}{sL_3} + \frac{1}{sL_4} + sC_5
 \end{bmatrix}
 \begin{bmatrix}
 U_{t1}(s) \\
 U_{t2}(s) \\
 U_{t3}(s)
 \end{bmatrix}
 =
 \begin{bmatrix}
 I_{S1}(s) \\
 I_{S2}(s) \\
 0
 \end{bmatrix}$$

2014 3 3

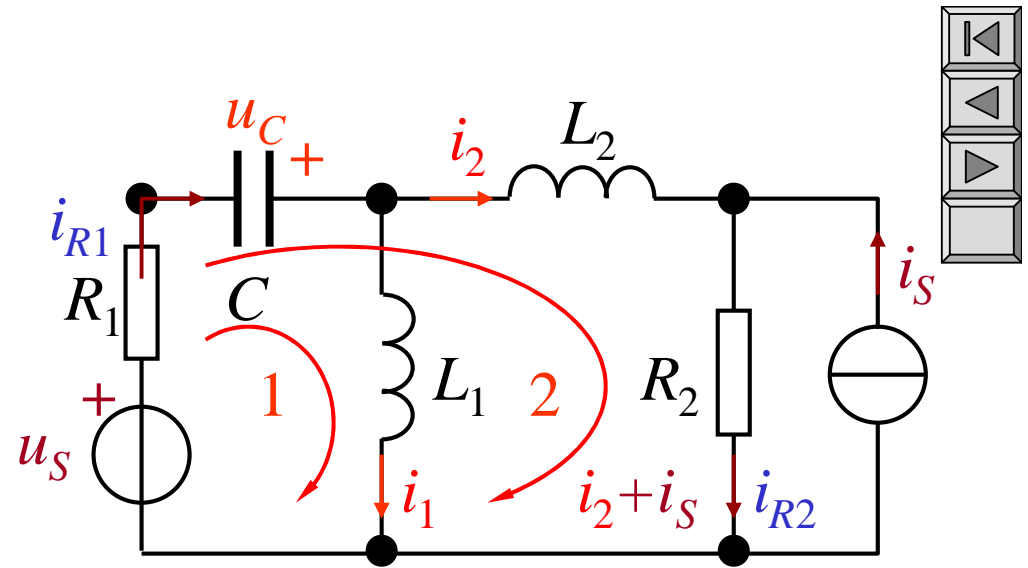

1.

$$C \frac{du_C}{dt} = -i_1 - i_2$$

$$1 \quad L_1 \frac{di_1}{dt} = u_C - \underbrace{R_1(i_1 + i_2)}_{i_{R1}} + u_S$$

$$2 \quad L_2 \frac{di_2}{dt} = u_C - R_1(i_1 + i_2) + u_S - \underbrace{R_2(i_2 + i_S)}_{i_{R2}}$$

(1) C

KCL

(2) L

KVL

(3) ()

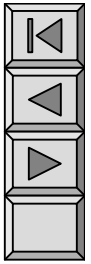

$$C \frac{du_C}{dt} = -i_1 - i_2 \quad (4)$$

$$L_1 \frac{di_1}{dt} = u_C - R_1(i_1 + i_2) + u_S$$

$$L_2 \frac{di_2}{dt} = u_C - R_1(i_1 + i_2) + u_S - R_2(i_2 + i_S)$$

$$\begin{bmatrix} \frac{du_C}{dt} \\ \frac{di_1}{dt} \\ \frac{di_2}{dt} \end{bmatrix} = \begin{bmatrix} 0 & -\frac{1}{C} & -\frac{1}{C} \\ \frac{1}{L_1} & -\frac{R_1}{L_1} & -\frac{R_1}{L_1} \\ \frac{1}{L_2} & -\frac{R_1}{L_2} & -\frac{R_1+R_2}{L_2} \end{bmatrix} \begin{bmatrix} u_C \\ i_1 \\ i_2 \end{bmatrix} + \begin{bmatrix} 0 & 0 \\ \frac{1}{L_1} & 0 \\ \frac{1}{L_2} & -\frac{R_2}{L_2} \end{bmatrix} \begin{bmatrix} u_S \\ i_S \end{bmatrix}$$

2.

(1)

(2)

KCL

(3)

KVL

(4)

(5)

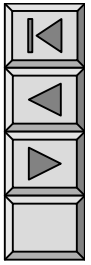

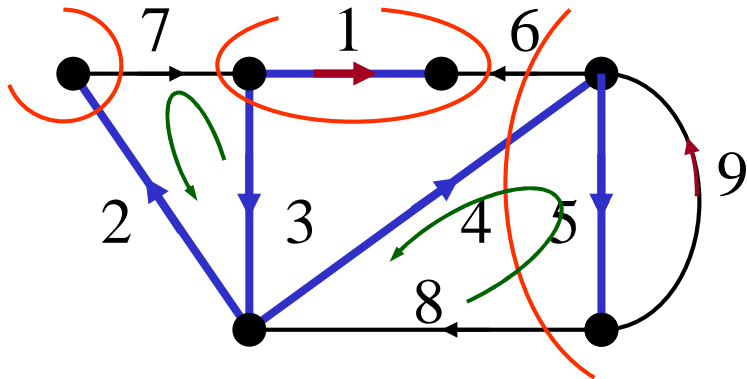

KCL

$$C_2 \frac{du_2}{dt} = i_7$$

$$C_3 \frac{du_3}{dt} = i_6 + i_7$$

$$C_4 \frac{du_4}{dt} = i_6 + i_8$$

2010 3 3

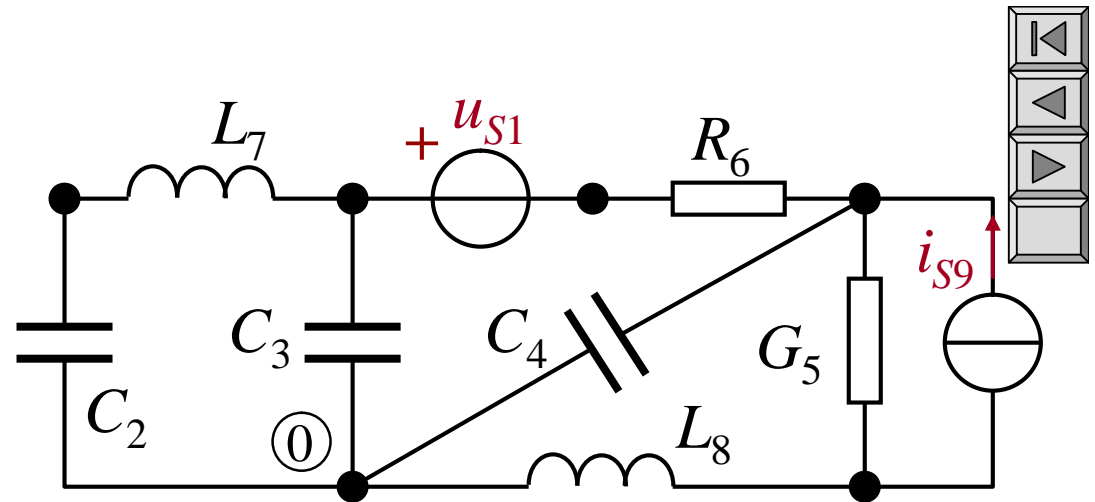

KVL

$$L_7 \frac{di_7}{dt} = -u_2 - u_3$$

$$L_8 \frac{di_8}{dt} = -u_4 - u_5$$

$$i_6 = u_5$$

$$i_6 = \frac{1}{R_6} u_6 = \frac{1}{R_6} (-u_4 - u_3 + u_{S1})$$

$$u_5 = \frac{1}{G_5} i_5 = \frac{1}{G_5} (i_8 + i_9)$$

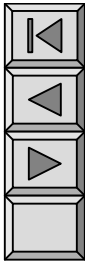

$$\frac{du_2}{dt} = \frac{1}{C_2} i_7$$

$$\frac{du_3}{dt} = -\frac{1}{C_3 R_6} u_3 - \frac{1}{C_3 R_6} u_4 + \frac{1}{C_3} i_7 + \frac{1}{C_3 R_6} u_{S1}$$

$$\frac{du_4}{dt} = -\frac{1}{C_4 R_6} u_3 - \frac{1}{C_4 R_6} u_4 + \frac{1}{C_4} i_8 + \frac{1}{C_4 R_6} u_{S1}$$

$$\frac{di_7}{dt} = -\frac{1}{L_7} u_2 - \frac{1}{L_7} u_3$$

$$\frac{di_8}{dt} = -\frac{1}{L_8} u_4 - \frac{1}{G_5 L_8} i_8 - \frac{1}{G_5 L_8} i_{S9}$$

$$u_2 = x_1 \quad u_3 = x_2 \quad u_4 = x_3 \quad i_7 = x_4 \quad i_8 = x_5$$

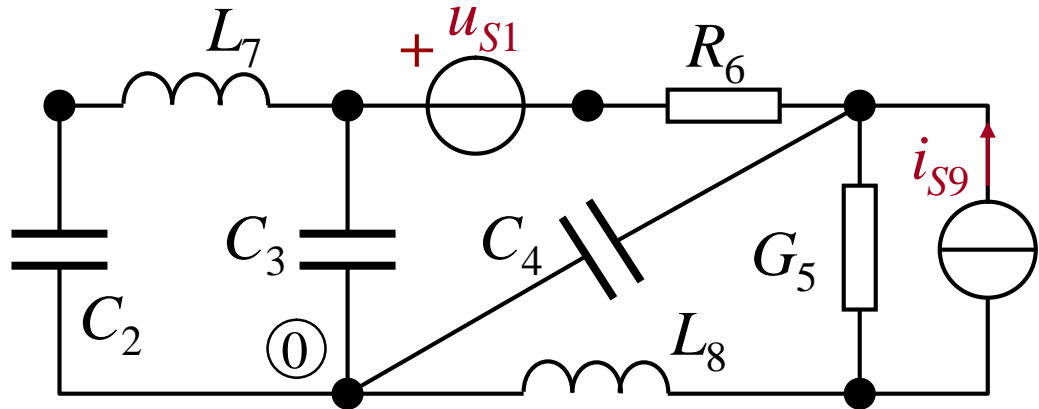
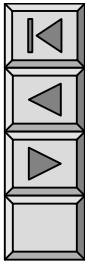

$$\begin{bmatrix} \dot{x}_1 \\ \dot{x}_2 \\ \dot{x}_3 \\ \dot{x}_4 \\ \dot{x}_5 \end{bmatrix} = \begin{bmatrix} 0 & 0 & 0 & \frac{1}{C_2} & 0 \\ 0 & \frac{1}{C_3 R_6} & \frac{1}{C_3 R_6} & \frac{1}{C_3} & 0 \\ 0 & \frac{1}{C_4 R_6} & \frac{1}{C_4 R_6} & 0 & \frac{1}{C_4} \\ \frac{1}{L_7} & \frac{1}{L_7} & 0 & 0 & 0 \\ 0 & 0 & \frac{1}{L_8} & 0 & \frac{1}{G_5 L_8} \end{bmatrix} \begin{bmatrix} x_1 \\ x_2 \\ x_3 \\ x_4 \\ x_5 \end{bmatrix} + \begin{bmatrix} 0 & 0 \\ \frac{1}{C_3 R_6} & 0 \\ \frac{1}{C_4 R_6} & 0 \\ 0 & 0 \\ 0 & \frac{1}{G_5 L_8} \end{bmatrix} \begin{bmatrix} u_{S1} \\ i_{S9} \end{bmatrix}$$

