(1)

(2)

$$I = \frac{I_{zd}}{I_{zd}} \quad (3-1)$$

$$a_1 = \frac{2}{N} \sum_{k=1}^N i(k) \sin\left(\frac{2k}{N}\right) \quad (3-2)$$
$$b_1 = \frac{2}{N} \sum_{k=1}^N i(k) \cos\left(\frac{2k}{N}\right)$$

$i(k)$

$k \quad N$

$$I_m = \sqrt{I_m^2 = a_1^2 + b_1^2}$$

$$I = I_m / \sqrt{2}$$

A

TQXDB-III

A

1

A

TQXDB-III

A

(1)

TQXDB-III

TQXDB-III

CPU

CPU

b.

3-5

PC

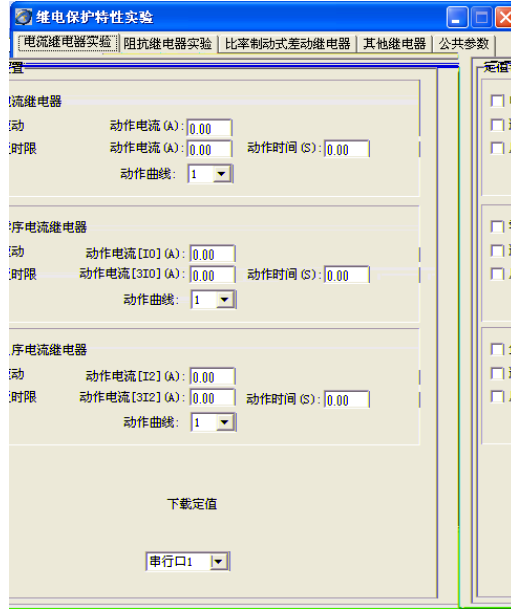

3-5

(3)

DL-31

3

3-1

3-1

	(A)	(A)	
1			
2			
3			
4			
(A)			
(%)			
(%)			
(A)			

DL-31

(1)

(2)

$$U \quad \begin{matrix} U & \sqrt{3}U_{zd} \\ & U_{zd} \end{matrix} \quad (3-3)$$

$$U \quad \begin{matrix} U & \sqrt{3}U_{zd} \\ & U_{zd} \end{matrix} \quad (3-4)$$

3-6

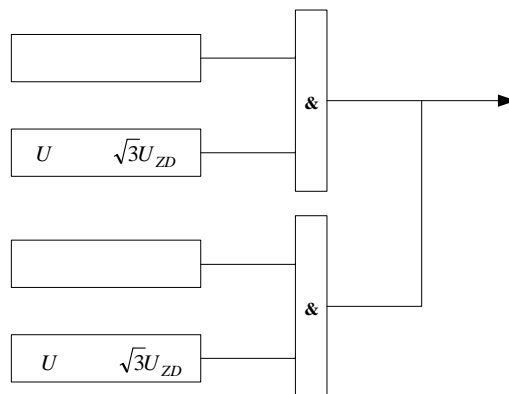

3-6

$$\begin{aligned} a_1 &= \frac{2}{N} \sum_{k=1}^N u(k) \sin\left(\frac{2k}{N}\right) \\ b_1 &= \frac{2}{N} \sum_{k=1}^N u(k) \cos\left(\frac{2k}{N}\right) \end{aligned} \quad (3-5)$$

$$u(k) \quad k \quad N$$

$$U_m \quad U_m^2 \quad a_1^2 \quad b_1^2$$

$$U \quad U_m / \sqrt{3}$$

A AB TQXDB-III
 A B

3.3.3

A B TQXDB-III A B

(1)

TQXDB-III

(3)

DY-36

3

U_{ab}

50V

50V

40V

60V

3-2

3-2

(

)

	(V)	(V)	
1			
2			
3			
4			
(V)			
(%)			
(%)			
(V)			

3-3

3-3

(

)

	(V)	(V)	
1			
2			
3			
4			
(V)			/
(%)			
(%)			
(V)			

DY-36

(1)

(2)

(1)
$$t \frac{0.14T_p}{[(I/I_p)^{0.02} - 1]}$$

(2)
$$t \frac{13.5T_p}{[(I/I_p) - 1]}$$

(3)
$$t \frac{80T_p}{[(I/I_p)^2 - 1]}$$

t T_p I

I_p

(1)
$$\sum_{n=1}^M \left[\left(\frac{I(n)}{I_p} \right)^{0.02} - 1 \right] = 0.14 \frac{T_p}{t}$$

(2)
$$\sum_{n=1}^M \left[\left(\frac{I(n)}{I_p} \right) - 1 \right] = 13.5 \frac{T_p}{t}$$

(3)
$$\sum_{n=1}^M \left[\left(\frac{I(n)}{I_p} \right)^2 - 1 \right] = 80 \frac{T_p}{t}$$

M $I(n)$ n I_p

T_p t

A

TQXDB-III

A



(2)

a.

2

- (1)
- (2)

3-8

$$I_d = I_{d.min} + KI_r \quad (3-7)$$

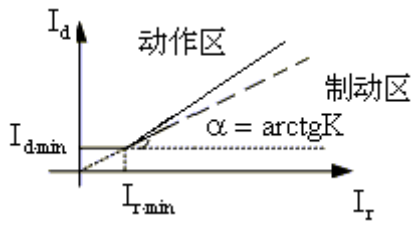

A 1 C 2

I_d I_r

$$I_d = I_A + I_C = I_r \frac{I_A + I_C}{2} \quad (3-8)$$

TQXDB-III

A C

(1)

TQXDB-III

(2)

2A

0.5

(3)

LCD-4

I_d I_r

3-7

3

0.4

3-7

K	1		2		3		4		5		6		7	
	I_d	I_r	I_d	I_r	I_d	I_r	I_d	I_r	I_d	I_r	I_d	I_r	I_d	I_r
0.5														
0.4														

$I_d f(I_r)$

- (1) 35kV
- (2) 35kV
- (3)

35kV

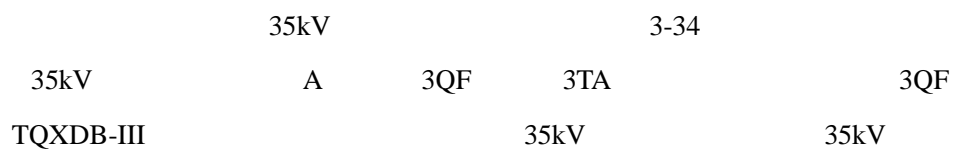
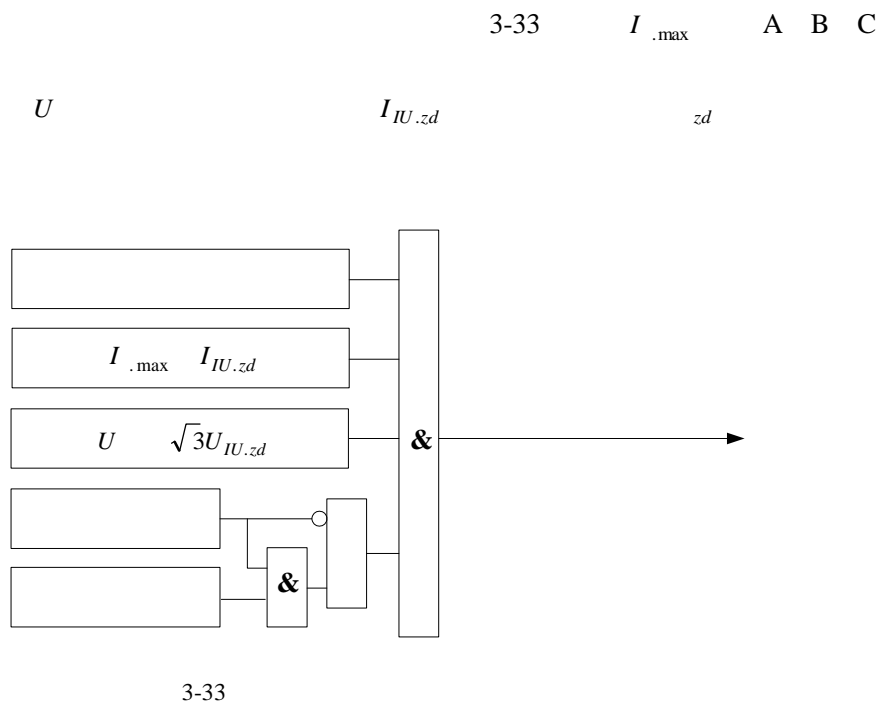

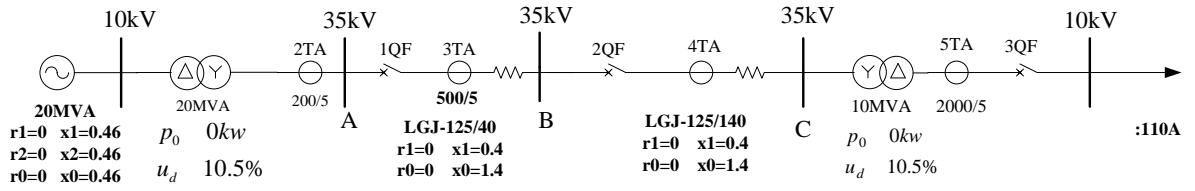

3-34 35kV

TQXDB-III

3QF

A

3QF

3QF

(1)

35kV

35kV

(2)

$$n_{TA} = \frac{1}{n_{TA}} = \frac{1}{n_{TV}}$$

(3)

ESC

(1)

AB BC

3-26

(2)

AB BC

II

III

I

3-26

II

III

I

III

0.05s

AB A 30%

3-27

3-26 35kV

		AB ___%+BC ___%
		AB ___%+BC ___%
		AB ___%+BC ___%
		AB ___%+BC ___%
		AB ___%+BC ___%
		AB ___%+BC ___%
		AB ___%+BC ___%
		AB ___%+BC ___%

3-27

		(ms)	(ms)
AB	A 30%		

3.20.4

(1)

(2)



$$S_B = 20MVA \quad U_{BI} = 35kV$$

$$X_G = 0.46 * \frac{10^2}{20} * \frac{35^2}{10} = 28.175$$

$$X_T = 0.105 * \frac{35^2}{20} = 6.43$$

$$X_{AB} = 0.4 * 40 = 16$$

$$X_{BC} = 0.4 * 140 = 56$$

$$35KV \quad E \quad E \quad 35/10 \quad 10.5 \quad 35/10 \quad 36.75KV$$

$$X_S \quad X_G \quad X_T = 34.605$$

$$AB \quad X_{.B} \quad X_G \quad X_T \quad X_{AB} = 50.605$$

$$BC \quad X_{.C} \quad X_G \quad X_T \quad X_{AB} \quad X_{BC} = 106.605$$

a.

TA

AB

$$= \frac{36.75}{1.732 * 50.605} = 0.419kA$$

AB

$$I_{d.B.min} = \frac{E}{2 * X_{.B}} = \frac{36.75}{2 * 50.605} = 0.363kA$$

BC

$$I_{d.C.max} = \frac{E}{\sqrt{3} * X_{.C}} = \frac{36.75}{1.732 * 106.605} = 0.199kA$$

BC

$$I_{d.C.min} = \frac{E}{2 * X_{.C}} = \frac{36.75}{2 * 106.605} = 0.172kA$$

b.

1

$$I'_{pu} \quad K'_k I_{d.B.max} = 1.2 * 0.419 = 0.5028kA \quad K'_k = 1.2$$

$$L_{MIN} = \frac{1}{X_1} \left(\frac{E'}{2I'_{pu}} X_{S.max} \right) = \frac{1}{0.4} \left(\frac{36.75}{2 * 0.5028} * 34.605 \right) = 4.85$$

$$\frac{L_{MIN}}{L} = \frac{4.85}{40} = 0.121 < 15\% \quad 1$$

c.

$$L_1 = 0.75 L_{AB}$$

$$I_{pu} = \frac{E'}{X_S X_0 L_1} = \frac{36.75}{1.732 * (34.605 + 0.75 * 16)} = 0.455 \text{ kA}$$

$$U_{pu} = \sqrt{3} I_{pu} X_0 L_1 = 1.732 * 0.455 * 0.75 * 16 = 9.4567 \text{ kV}$$

d. 2

$$B \quad 1 \quad I'_{pu.B} = K'_k I_{d.C.\max} = 1.2 * 0.199 = 0.2388 \text{ kA}$$

$$I''_{pu} = k''_k * I'_{pu.B} = 1.1 * 0.2388 = 0.262 \text{ kA} \quad k''_k = 1.1$$

$$k_{lm} = \frac{I_{d.B.\min}}{I''_{pu}} = \frac{0.363}{0.262} = 1.385 > 1.3$$

$$t''_1 = t'_2 + t \quad t = 0.5 \quad t''_1 = 0.5 \text{ S}$$

e. 3

$$110 \text{ A} = 0.11 \text{ kA}$$

$$\text{III} \quad I'''_{pu} = \frac{k_k * k_{zq}}{k_h} * I_{f.\max} = \frac{1.15 * 1}{0.95} * 0.11 = 0.133 \text{ kA} \quad k'''_k = 1.15$$

1 0.95

$$k_{lm} = \frac{I_{d.B.\min}}{I'''_{pu}} = \frac{0.363}{0.133} > 1.3$$

$$k_{lm} = \frac{I_{d.C.\min}}{I'''_{pu}} = \frac{0.172}{0.133} > 1.2$$

f.

$$n_{TA} = \frac{TA}{500/5} = \frac{TA}{100} \quad n_{TV} = \frac{TV}{35 * 1000/100}$$

1 0.5028 kA/100 = 5.03 A

2 $0.262\text{kA}/100=2.62\text{A}$

3 $0.133\text{kA}/100=1.33\text{A}$

$0.455\text{kA}/100=4.55\text{A}$

$9.4567\text{kV}\cdot 100/35000/1.732=15.6\text{V}$

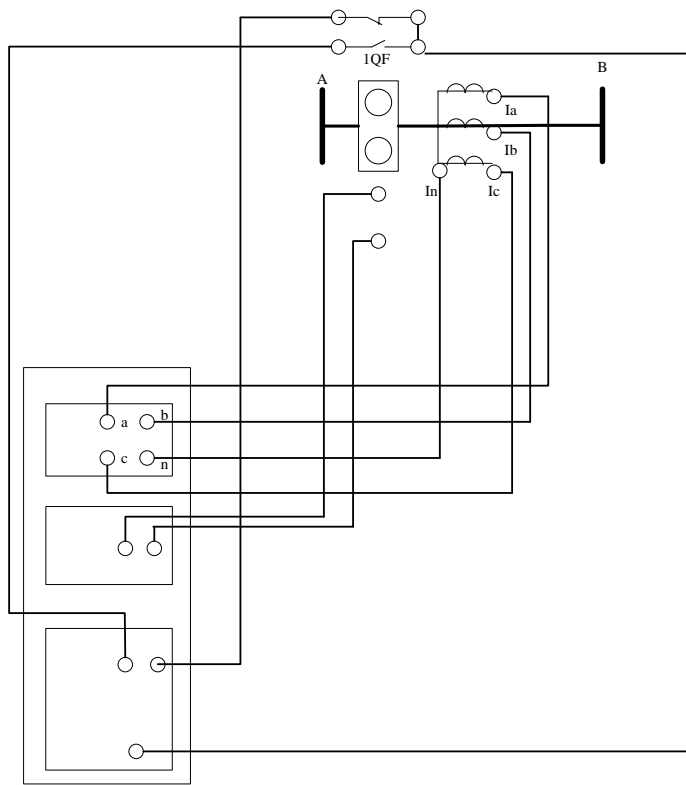

3-2 (10kV)

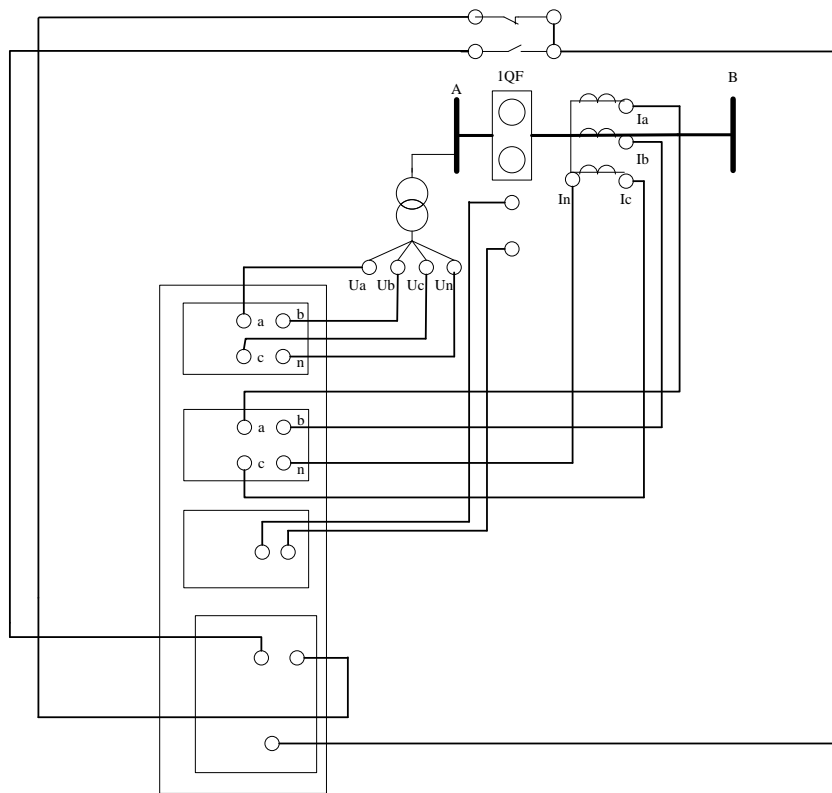

110kV